

# User Guide

## MOBOTIX MOVE 2MP Vandal Dome Camera

© 2024 MOBOTIX AG



 HEVCAdvance™

BeyondHumanVision

**MOBOTIX** MOVE

# Table of Contents

---

<b>Table of Contents</b> .....	<b>2</b>
<b>Before You Start</b> .....	<b>5</b>
Support .....	6
MOBOTIX Support .....	6
MOBOTIX eCampus .....	6
MOBOTIX Community .....	6
Safety Notes .....	6
Legal Notes .....	7
<b>Overview</b> .....	<b>9</b>
Features .....	10
Package Contents .....	10
Dimensions .....	10
Accessories .....	11
Further Reading .....	12
<b>Connection</b> .....	<b>13</b>
Camera Cabling .....	14
Camera Connectors .....	14
microSD Card Slot .....	15
Reset Button .....	15
Connecting Power .....	15
Connecting Ethernet Cable .....	15
<b>Installation</b> .....	<b>17</b>
General Remarks .....	18
Camera Installation .....	18
<b>Configuration</b> .....	<b>21</b>
System Requirements for Operating the Camera .....	22
Accessing the Camera .....	22
Setting the Video Resolution .....	24
Default Resolution .....	24
Adjusting and Focusing the Camera’s Field of View .....	25
Exporting/Importing Configuration Files .....	26
<b>Menu Reference</b> .....	<b>27</b>
The Camera Menu .....	29
The “Home” Tab .....	30
Function Items on Home Page .....	31

---

The “System” Tab .....	33
System .....	33
Security .....	35
Network .....	42
DDNS .....	49
Mail .....	49
FTP .....	50
HTTP .....	50
Events (Alarm Settings) .....	50
Storage Management .....	59
Recording .....	63
Schedule .....	64
File Location (Snapshots and Web Recording) .....	66
View Information .....	66
Factory Default .....	67
Software Version .....	67
Software Upgrade .....	68
Maintenance .....	68
The “Streaming” Tab .....	69
Video Configuration .....	69
Video Rotation .....	72
Video Text Overlay .....	72
Video ROI .....	73
Video ROI Encoding .....	74
Video OCX Protocol .....	75
Video Mask .....	75
The “Camera” Tab .....	77
Exposure .....	77
White Balance .....	80
Picture Adjustment .....	84
Color Style .....	85
IR Function .....	85
Noise Reduction .....	87
WDR Function .....	88
Digital Zoom .....	88
Backlight .....	88
Defog .....	88
Profile .....	88

---

## Table of Contents

---

TV System .....	89
The “Logout” Tab .....	91
Appendix A: Installing UPnP Components .....	92
Appendix B: Converting IP Addresses from Decimal to Binary .....	92
Appendix C: List of Open/Closed IP Ports .....	94
TCP Protocol .....	94
UDP Protocol .....	94
<b>Technical Support Information .....</b>	<b>97</b>
Technical Specifications .....	98

## Before You Start

This section contains the following information:

<b>Support</b> .....	<b>6</b>
MOBOTIX Support .....	6
MOBOTIX eCampus .....	6
MOBOTIX Community .....	6
<b>Safety Notes</b> .....	<b>6</b>
<b>Legal Notes</b> .....	<b>7</b>

# Support

## MOBOTIX Support

If you need technical support, please contact your MOBOTIX dealer. If your dealer cannot help you, he will contact the support channel to get an answer for you as quickly as possible.

If you have internet access, you can open the MOBOTIX help desk to find additional information and software updates.

Please visit [www.mobotix.com](http://www.mobotix.com) > [Support](#) > [Help Desk](#).



## MOBOTIX eCampus

The MOBOTIX eCampus is a complete e-learning platform. It lets you decide when and where you want to view and process your training seminar content. Simply open the site in your browser and select the desired training seminar.

Please visit [www.mobotix.com/ecampus-mobotix](http://www.mobotix.com/ecampus-mobotix).



## MOBOTIX Community

The MOBOTIX community is another valuable source of information. MOBOTIX staff and other users are sharing their information, and so can you.

Please visit [community.mobotix.com](http://community.mobotix.com).



## Safety Notes

- This camera must be installed by qualified personnel and the installation should conform to all local codes.

- This product must not be used in locations exposed to the dangers of explosion.
- Do not look directly into the infra-red LEDs that may be active on the product.
- Do not use this product in a dusty environment.
- Protect this product from moisture or water entering the housing.
- Install this product as outlined in this document. A faulty installation can damage the product!
- Do not replace batteries of the camera. If a battery is replaced by an incorrect type, the battery can explode.
- This equipment is not suitable for use in locations where children are likely to be present.
- External power supplies must comply with the Limited Power Source (LPS) requirements and share the same power specifications with the camera.
- When using a Class I adapter, the power cord shall be connected to a socket-outlet with proper ground connection.
- To comply with the requirements of EN 50130-4 regarding the power supply of alarm systems for 24/7 operation, it is highly recommended to use an uninterruptible power supply (UPS) for backing up the power supply of this product.

**NOTE!** Observe the [MOBOTIX MOVE Installation Hints](#) document to ensure optimum performance of the camera features.

## Legal Notes

### Legal Aspects of Video and Sound Recording

You must comply with all data protection regulations for video and sound monitoring when using MOBOTIX AG products. Depending on national laws and the installation location of the cameras, the recording of video and sound data may be subject to special documentation or it may be prohibited. All users of MOBOTIX products are therefore required to familiarize themselves with all applicable regulations and to comply with these laws. MOBOTIX AG is not liable for any illegal use of its products.

### Declaration of Conformity

The products of MOBOTIX AG are certified according to the applicable regulations of the EC and other countries. You can find the declarations of conformity for the products of MOBOTIX AG on [www.mobotix.com](http://www.mobotix.com) under **Support > Download Center > Marketing & Documentation > Certificates & Declarations of Conformity**.

## RoHS Declaration

The products of MOBOTIX AG are in full compliance with European Unions Restrictions of the Use of Certain Hazardous Substances in Electrical and Electronic Equipment (RoHS Directive 2011/65/EC) as far as they are subject to these regulations (for the RoHS Declaration of MOBOTIX, please see [www.mobotix.com](http://www.mobotix.com), **Support > Download Center > Marketing & Documentation > Brochures & Guides > Certificates**).

## Disposal

Electrical and electronic products contain many valuable materials. For this reason, we recommend that you dispose of MOBOTIX products at the end of their service life in accordance with all legal requirements and regulations (or deposit these products at a municipal collection center). MOBOTIX products must not be disposed of in household waste! If the product contains a battery, please dispose of the battery separately (the corresponding product manuals contain specific directions if the product contains a battery).

## Disclaimer

MOBOTIX AG does not assume any responsibility for damages, which are the result of improper use or failure to comply to the manuals or the applicable rules and regulations. Our General Terms and Conditions apply. You can download the current version of the **General Terms and Conditions** from our website at [www.mobotix.com](http://www.mobotix.com) by clicking on the corresponding link at the bottom of every page.

It is the User's responsibility to comply with all applicable local, state, national and foreign laws, rules, treaties and regulations in connection with the use of the Software and Product, including those related to data privacy, the Health Insurance Portability and Accountability Act of 1996 (HIPPA), international communications and the transmission of technical or personal data.



## Overview

This section contains the following information:

<b>Features</b> .....	<b>10</b>
<b>Package Contents</b> .....	<b>10</b>
<b>Dimensions</b> .....	<b>10</b>
<b>Accessories</b> .....	<b>11</b>
<b>Further Reading</b> .....	<b>12</b>

## Features

A performant 2MP, full HD 1080p resolution camera for the daily security and surveillance needs. The camera easily adapts to different indoor and outdoor scenes.

- 2.8 to 12 mm Manual Vari-Focal Lens
- Wide Dynamic Range (WDR) max. 130 dB
- Light Sensitivity: Color 0.08 lux, B/W 0.008 lux
- PoE power support (IEEE802.3af)
- Integrated IR LEDs up to 40 m/131 ft distance
- Outdoor suitable (IP66) and vandal proof design (IK10)
- ONVIF Profile S/G/T/M support
- Temperature Range -55 to 60 °C/-67 to 140 °F

**NOTE!** Observe the [MOBOTIX MOVE Installation Hints](#) document to ensure optimum performance of the camera features.

## Package Contents

Check the package for the items listed below.

**NOTE!** The supplied self-tapping screws are for soft substances/materials such as wood. For other installation environments, such as solid or sheet rock walls, users **MUST** pre-drill and use plastic anchors before fastening the camera onto the wall.

**CAUTION!** Do not replace batteries of the camera. Risk of explosion may occur if the battery is replaced by an incorrect type.

## Dimensions

**NOTE!** Download the drilling template from the MOBOTIX website: [www.mobotix.com](http://www.mobotix.com) > [Support](#) > [Download Center](#) > [Marketing & Documentation](#) > [Drilling Templates](#).

**CAUTION!** Always print or copy the drilling template at 100% of the original size!

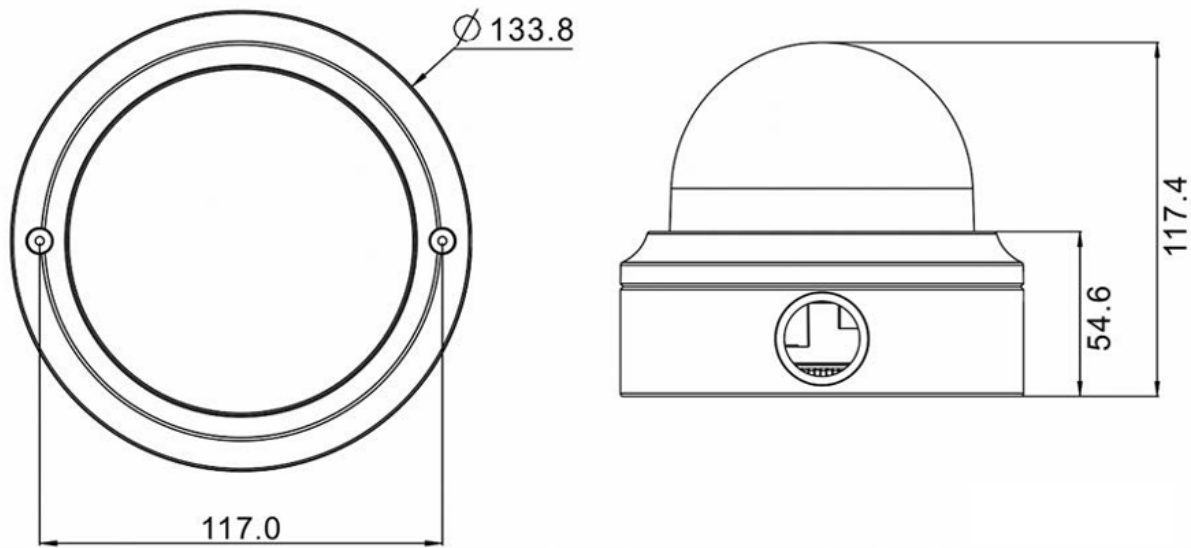







Fig. 1: 2MP Vandal Dome Camera: All measurements in mm



## Accessories

Picture	Order Code	Description
	Mx-M-VD-W	Wall Mount set (2 pieces) for MOBOTIX MOVE Vandal Dome cameras
	Mx-M-VD-P	Pole Mount (junction mount) for MOBOTIX MOVE Vandal Dome cameras
	Mx-M-VD-C	Corner Mount for MOBOTIX MOVE Vandal Dome cameras
	Mx-M-VD-IC	Ceiling Flush Mount for MOBOTIX MOVE Vandal Dome cameras
	Mx-M-VD-DCT	Clear Replacement Dome for MOBOTIX MOVE Vandal Dome cameras
	Mx-M-VD-DCS	Tinted (smoked) Replacement Dome for MOBOTIX MOVE Vandal Dome cameras

## Overview

### Further Reading

---

Picture	Order Code	Description
	Mx-NPA-UPOE1A-60W	UPoE Network Power Injector 60 W
	Mx-A-ETP1A-2601-SET	Media Converter Set Ethernet (PoE+) - Twisted-Pair

---

## Further Reading

[Manuals and Quick Installation documents](#)



[Technical Specifications](#)



[MOBOTIX MOVE Installation Hints](#)



## Connection

This section contains the following information:

<b>Camera Cabling</b> .....	<b>14</b>
Camera Connectors .....	14
microSD Card Slot .....	15
Reset Button .....	15
<b>Connecting Power</b> .....	<b>15</b>
<b>Connecting Ethernet Cable</b> .....	<b>15</b>

## Camera Cabling

Before users connect cables, make sure that all cables and the power adapter are placed in dry and well-waterproofed environments, e.g. waterproof boxes. The purpose is to prevent moisture accumulation inside the camera and moisture penetration into cables, which might lead to device breakdown. Please refer to the following sections for camera connection.

**NOTE!**

This camera must be installed by qualified personnel and the installation should conform to all local codes.

### Camera Connectors

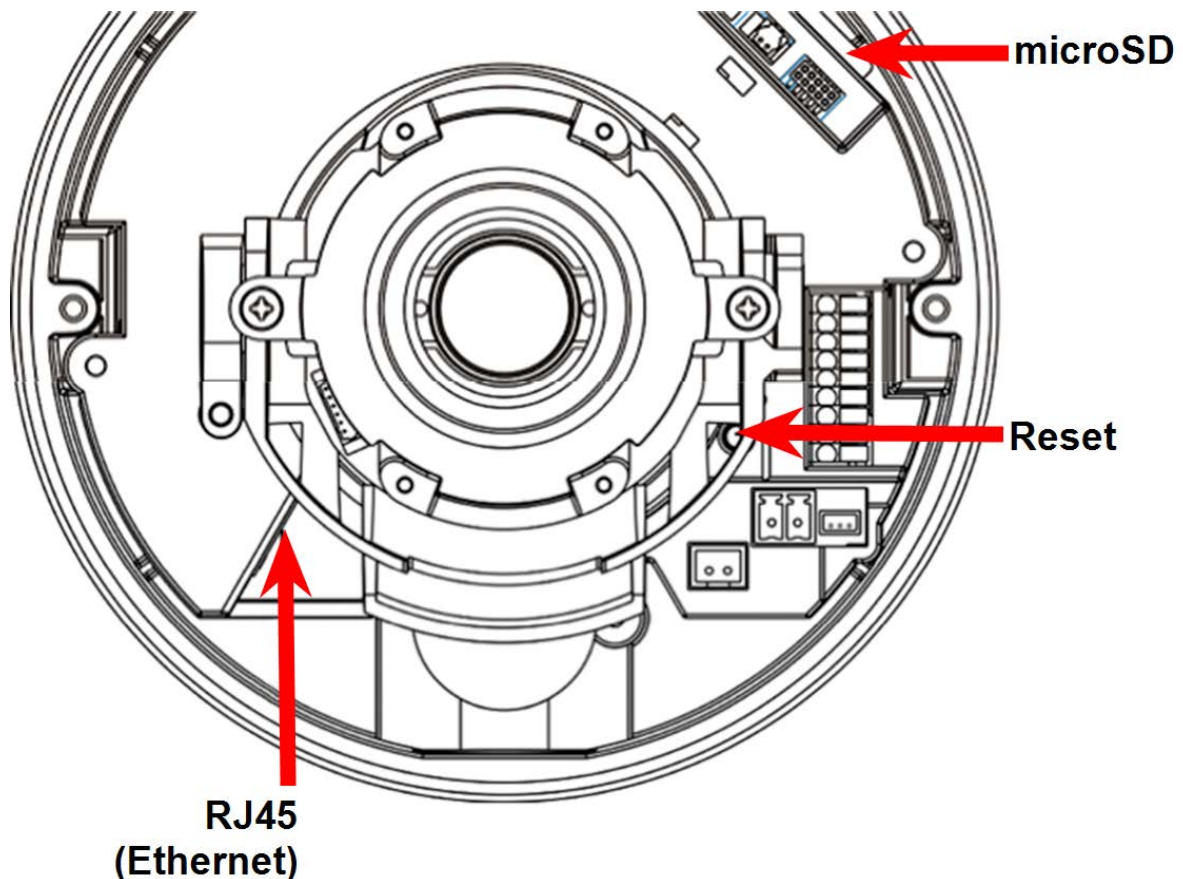

## microSD Card Slot

- Insert the microSD card into the card slot to store videos and snapshots.
- Do not remove the microSD card when the camera is powered on.

### NOTE!

It is not recommended to record with the SD card for 24/7 continuously, as it may not be able to support long term continuous data read/write. Please contact the manufacturer of the SD card for information regarding the reliability and life expectancy.

## Reset Button

Press the Reset button with a proper tool for at least 20 seconds to apply the factory defaults.

## Connecting Power

### Using Power over Ethernet (PoE)

Use a PoE switch (Class 0) and connect the Ethernet cable to the RJ-45 port of the camera.

## Connecting Ethernet Cable

### Ethernet Cable Connection

Connect one end of the Ethernet cable to the RJ-45 connector of the camera and plug the other end of the cable into the network switch or PC.

### NOTE!

- The length of the Ethernet cable should not exceed 100 m/300 ft.
- Check the status of the link indicator and the activity indicator LEDs of the switch. If the LEDs are unlit, please check the LAN connection.
- In some cases, an Ethernet crossover cable may be needed when connecting the camera directly to the PC.

#### Ethernet Connector LEDs

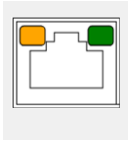

- Green **Link** LED indicates good network connection.
- Orange **Activity** LED flashes to indicate network activity.



## Installation

This section contains the following information:

<b>General Remarks</b> .....	<b>18</b>
<b>Camera Installation</b> .....	<b>18</b>

## General Remarks

Read the instructions provided in this chapter thoroughly before installing the camera.

**NOTE!** This camera must be installed by qualified personnel and the installation must conform to all local codes.

**NOTE!** Observe the [MOBOTIX MOVE Installation Hints](#) document to ensure optimum performance of the camera features.

## Camera Installation

The following description demonstrates how to directly install the camera to the ceiling or to the wall.

1. Loosen the two security screws on the camera with the supplied security Torx wrench and remove the dome cover.
2. Open the back conduit entry block using a coin and place it to the side conduit entry.
3. Place the camera at the installation location. Mark the position of the two screw holes and the back conduit entry (for cable entry) indicated in the right figure on the ceiling or wall.



4. On the ceiling or wall, drill the round cable entry hole (back conduit entry).

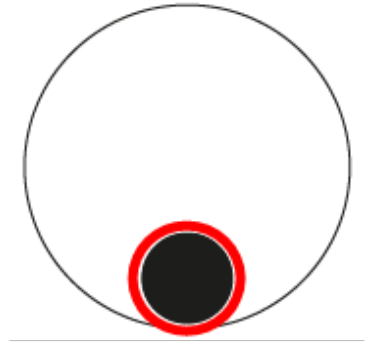

5. Drill holes for the plastic screw anchors on each marked screw hole. Then insert the plastic screw anchors into the drilled holes.
6. Thread the cables through the cable entry hole. Match the two screw holes on the camera with the plastic screw anchors at the installation location. Fasten the camera with the supplied self-tapping screws.
7. Attach the dome cover to the camera and fasten the two Torx security screws.





## Configuration

This section contains the following information:

<b>System Requirements for Operating the Camera</b> .....	<b>22</b>
<b>Accessing the Camera</b> .....	<b>22</b>
<b>Setting the Video Resolution</b> .....	<b>24</b>
Default Resolution .....	24
<b>Adjusting and Focusing the Camera's Field of View</b> .....	<b>25</b>
<b>Exporting/Importing Configuration Files</b> .....	<b>26</b>

# System Requirements for Operating the Camera

To operate the IP camera via web browser, please ensure the PC is in good network connection and meets system requirements as described below.

Items	System Requirements
Personal Computer	Minimum: <ul style="list-style-type: none"><li>▪ Intel® Core™ i5-2430M @ 2.4 GHz</li><li>▪ 4 GB RAM</li></ul> Recommended: <ul style="list-style-type: none"><li>▪ 8 GB RAM</li></ul>
Operating System	Windows 7 or later operating system
Web Browser	Any current web browser
Network Card	10Base-T (10 Mbps), 100Base-TX (100 Mbps) or 1000Base-T operation

**NOTE!** The ITE is to be connected only to PoE networks without routing to the outside plant or equivalent description.

## Accessing the Camera

### Accessing the Camera

The 2MP Vandal Dome Camera supports all current browsers without requiring any additional plug-ins or add-ons (e.g. for H.264/H.265/MJPEG support).

### Camera Login

The default IP address of the camera is: 10.x.x.x. By default, the camera starts as DHCP client and automatically tries to get an IP address from a DHCP server.

1. Enter the camera's IP address in the URL bar of the web browser and hit "Enter".
2. Enter the default username (**admin**) and password (**meinsm**).

**NOTE!** User names and passwords are case sensitive.

3. You will be prompted to set a new admin user password.

**NOTE!** The password can have between 6 and 14 characters (at least one digit, no special characters allowed).

4. After setting a new password, you will be prompted to log in again. Remember to use the new password.

## Fixed Lens Models

The screenshot displays the MOBOTIX MOVE web interface. At the top, there is a navigation bar with tabs: Home, System, Streaming, Camera, and Logout. A language selection dropdown is set to English. Below the navigation bar, there is a 'Stream 1' dropdown menu for 'Video Stream Selection' and a 'Current Video Time' display showing '2021/09/02 15:43'. The main area is a live video stream of a train station platform with several high-speed trains. Below the video stream, there is a control bar with various icons. A red box highlights the video stream information: 'Stream1 H264 bitrate: 12288 kbps low compression, high quality' and 'Stream2 MJPEG bitrate: low compression, high quality'. Arrows point from these icons to their respective functions: Video Stream Info, Video Quality Info, Full Screen, Talk, Listen, Snapshot, Pause Video, Record Video, and Manual Trigger.

**NOTE!** Refer to section [Menu Reference, p. 27](#) of the Vandal Dome WDR IP camera for more button function details.

# Setting the Video Resolution

To edit the video configuration settings, select **Streaming > Video Configuration**.

## Default Resolution

The following table lists the default resolution of the camera.

IP Camera Model	WDR on/off	Default Resolution
2MP Vandal Dome Camera Mx-VD2A-2-IR		H.265/H.264: 1920 × 1080 (30 fps) + MJPEG: 1080p (30 fps)



# Adjusting and Focusing the Camera's Field of View

1. Remove the two security screws and take off the dome.
2. Adjust the camera's field of view:
  - Loosen the 3-axis gimbal screws.
  - Check the camera image on a computer and reposition the camera as required.
  - Tighten the gimbal screws again.
3. Fully open the iris of the lens using one of these methods:
  - Manually increase the shutter speed to e.g., 1/1000 s or higher (depending on ambient illumination) until the video is getting visibly darker.
  - Add as many ND (neutral density) filters until the camera has reached the limit of exposure control and the video is getting visibly darker.
4. Loosen the focal length lever① (wide/tele) and move it until the camera shows the desired image, then tighten the lever again.
5. Loosen the focus lever② and move it until you get a sharp and crisp picture, then tighten the lever again.
6. Depending on the method used in step 3, set the shutter speed back to automatic mode or remove the ND filters, respectively.
7. Mount the dome and tighten the two security screws.



**NOTE!** Take care to properly tighten the focal length lever①, the focus lever②, and the screws of the 3-axis gimbal to prevent unwanted changes due to vibration, for example.

## Exporting/Importing Configuration Files

To export and import configuration files, you can access the Maintenance page on the user-friendly browser-based configuration interface.

To edit the Maintenance settings, select **System > Maintenance**.

You can export configuration files to a specified location and retrieve data by uploading an existing configuration file to the camera. This is especially convenient to make multiple cameras having the same configuration.

### Export

You can save the system settings by exporting the configuration file (.bin) to a specified location for future use.

- Click on the **Export** button, and the popup File Download window will come out.
- Click on **Save** and specify a desired location for saving the configuration file.

### Upload

To upload a configuration file to the camera, click on **Browse** to select the configuration file, and then click on the **Upload** button for uploading.

## Menu Reference

This section contains the following information:

<b>The Camera Menu</b> .....	<b>29</b>
<b>The “Home” Tab</b> .....	<b>30</b>
Function Items on Home Page .....	31
<b>The “System” Tab</b> .....	<b>33</b>
System .....	33
Security .....	35
Network .....	42
DDNS .....	49
Mail .....	49
FTP .....	50
HTTP .....	50
Events (Alarm Settings) .....	50
Storage Management .....	59
Recording .....	63
Schedule .....	64
File Location (Snapshots and Web Recording) .....	66

View Information .....	66
Factory Default .....	67
Software Version .....	67
Software Upgrade .....	68
Maintenance .....	68
<b>The “Streaming” Tab .....</b>	<b>69</b>
Video Configuration .....	69
Video Rotation .....	72
Video Text Overlay .....	72
Video ROI .....	73
Video ROI Encoding .....	74
Video OCX Protocol .....	75
Video Mask .....	75
<b>The “Camera” Tab .....</b>	<b>77</b>
Exposure .....	77
White Balance .....	80
Picture Adjustment .....	84
Color Style .....	85
IR Function .....	85
Noise Reduction .....	87
WDR Function .....	88
Digital Zoom .....	88
Backlight .....	88
Defog .....	88
Profile .....	88
TV System .....	89
<b>The “Logout” Tab .....</b>	<b>91</b>
<b>Appendix A: Installing UPnP Components .....</b>	<b>92</b>
<b>Appendix B: Converting IP Addresses from Decimal to Binary .....</b>	<b>92</b>
<b>Appendix C: List of Open/Closed IP Ports .....</b>	<b>94</b>
TCP Protocol .....	94
UDP Protocol .....	94

# The Camera Menu

The camera's Home Page shows these main tabs at the top:

## **The “Home” Tab, p. 30**

You can monitor the live video of the targeted area.

## **The “System” Tab, p. 33**

The administrator can set host name, system time, root password, network related settings, etc.

## **The “Streaming” Tab, p. 69**

The administrator can configure video format, video compression, video OCX protocol, video frame rate and audio compression in this page.

## **The “Camera” Tab, p. 77**

This tab contains the camera-related settings and is only available for the administrator and user accounts with camera control privileges.

## **The “Logout” Tab, p. 91**

Click on the tab to log out of the camera system. Click on **Login** to log in again with a different user-name and password, for example.

# The “Home” Tab

Click on the tab **Home** to access the Home Page. There are several function buttons on this page. Detailed information of each item is as described in the following section.

The screenshot shows the ROBOTIX MOVE Home page. At the top, there is a navigation bar with the logo 'ROBOTIX MOVE' on the left and a menu with 'Home', 'System', 'Streaming', 'Camera', and 'Logout' on the right. A 'Language Selection' dropdown is set to 'English'. Below the navigation bar, there is a 'Stream 1' dropdown menu labeled 'Video Stream Selection' and a 'Current Video Time' display showing '2021/09/02 15:43'. The main content area features a large video stream of a train station. Below the video, there is a row of control icons: a camera icon, a full screen icon, a microphone icon, a speaker icon, a camera icon, a video camera icon, a red record icon, and a bell icon. A red box highlights the text 'Stream1 H264 bitrate : 12288 kbps low compression, high quality' and 'Stream2 MJPEG bitrate : low compression, high quality'. Arrows point from these icons and text to labels: 'Video Stream Info' points to the bitrate text; 'Video Quality Info' points to the 'low compression, high quality' text; 'Full Screen' points to the full screen icon; 'Talk' points to the microphone icon; 'Listen' points to the speaker icon; 'Snapshot' points to the camera icon; 'Pause Video' points to the video camera icon; 'Record Video' points to the red record icon; and 'Manual Trigger' points to the bell icon.

**NOTE!** The function buttons on the Home page will vary for different camera models.

## Function Items on Home Page

### Multiple Languages Support

The 2MP Vandal Dome Camera supports different languages for the browser interface, including German, English, Spanish, French, Italian, Japanese, Portuguese, Russian, Simplified Chinese, and Traditional Chinese.

### Display Stream Selection

According to the streaming setting, you can choose the one stream to display from the drop-down menu.

### Digital Zoom Control

In full screen mode you can use the digital PTZ by rotating the mouse wheel (for zooming in/out). Once you have zoomed in, you can drag the mouse in any direction to move the zoomed image.

### Camera Info

Double-click on the live view pane, and the camera info window will pop up. You can instantaneously check the basic information of the camera, such as IP address, network status, video format, etc.

### Video Quality

Click to show/hide the video quality information including bitrate and compression.

### Full Screen

Use this button to switch the image display to full screen. Alternatively, right click on the **Live Video** pane and select **Fullscreen**.

To exit full screen mode:

- Tap **Esc** on the keyboard.
- Double-click on the **Live Video** pane.
- Right-click on the **Live Video** pane and select **Normal view**.

#### Snapshot

Click on the button and the JPEG snapshots will automatically be saved in the appointed place. The default place of saving snapshots is: C:\. To change the storage location, please see [File Location \(Snapshots and Web Recording\)](#), p. 66 for further details.

#### Live View (Pause/Restart)

Click on **Pause** to disable video streaming, the live video will be displayed as black. Click on **Restart** to show the live video again.

#### Record (On/Off)

Click on **Record** and the Live View through the web browser will be directly recorded to the specific location on the local hard drive, which could be configured in the File Location page. The default storage location for the web recording is: C:\. Please see [File Location \(Snapshots and Web Recording\)](#), p. 66 for further details.

#### Manual Trigger (On/Off)

Click on **Manual Trigger** to activate/deactivate the manual trigger. Please see [Manual Trigger](#), p. 59 for further details.



# The “System” Tab

The screenshot displays the MOBOTIXMOVE web interface. At the top, there is a navigation bar with 'MOBOTIXMOVE' on the left and 'Home', 'System', 'Streaming', 'Camera', and 'Logout' in the center. A language dropdown menu on the right is set to 'English'. A dark blue sidebar on the left lists various system management categories, with 'System' selected. The main content area is titled 'System' and contains the following configuration options:

- Host Name :** [text input field]
- Time zone :** [dropdown menu: GMT+01:00 Tunisia, France, Germany, Italy]
- Enable daylight saving time**
- Time offset:** [text input field: 01:00:00]
- Start date:** [dropdown menu: Mar] **Start time:** [text input field: 00:00:00]
- [dropdown menu: last week]
- [dropdown menu: Sun]
- End date:** [dropdown menu: Oct] **End time:** [text input field: 00:00:00]
- [dropdown menu: last week]
- [dropdown menu: Sun]
- Time format:** [dropdown menu: yyyy/mm/dd]
- Sync with computer time**
- PC date:** [text input field: 2022/06/28] [small text: [yyyy/mm/dd]]
- PC time:** [text input field: 15:51:04] [small text: [hh:mm:ss]]
- Manual**
- Date:** [text input field: 2016/04/01] [small text: [yyyy/mm/dd]]
- Time:** [text input field: 00:00:00] [small text: [hh:mm:ss]]
- Sync with NTP server**
- NTP server:** [text input field: ntptime3.nth.de]
- Save** [button]

**NOTE!** Only administrators can access the **System** configuration page.

## System

To edit the system settings, select **System > System**.

## Host Name

The name is for camera identification. If alarm actions (see [Triggered Actions \(Common to All Event Types\)](#), p. 51) are enabled and is set to send alarm messages by Mail/FTP, the host name entered here will be displayed in the alarm message.

## Time Zone

Select the time zone from the drop-down menu according to the location of the camera.

## Enable Daylight Saving Time

To enable DST, please check the item and then specify the time offset and the DST duration. The format for time offset is [hh:mm:ss]; for instance, if the amount of time offset is one hour, please enter “01:00:00” into the field.

## Time format

Choose a time format (yyyy/mm/dd or dd/mm/yyyy) from the drop-down menu. The format of the date and time displayed above the live video window will be changed according to the selected format.

## Sync with Computer Time

Select the item, and video date and time display will synchronize with the PC’s.

**NOTE!** Users MUST click on **Save** to confirm the setting. Otherwise, the time will not be synced.

## Manual

The administrator can set video date and time manually. Entry format should be identical with the examples shown next to the enter fields.

## Sync with NTP Server

Network Time Protocol (NTP) is an alternate way to synchronize the camera’s clock with a NTP server. Please specify the server that is wished to synchronize in the entry field. Then select an update interval from the drop-down menu. For further information about NTP, please open the web site [www.ntp.org](http://www.ntp.org).

**NOTE!** The synchronization will be done every time the camera boots up.

Click on **Save** to apply and store the settings.

## Security

To edit the security settings, select **System > Security**.

Click on **Security**, there will be a drop-down menu with tabs including **User**, **HTTPS**, **IP Filter**, and **IEEE 802.1X**.

### User

To edit the user settings, select **System > Security > User**.

#### Admin Password

This item is for the administrator to reset password. Enter the new password in **Admin password** and **Confirm password**. The input characters will be displayed as dots for security purposes. Click on **Save** to confirm the changes. After the changes are confirmed, the web browser will ask the administrator to login again using the new password.

**NOTE!** The password can have between 6 and 14 characters (at least one digit, no special characters allowed).

#### Add User

This item is for the administrator to add new users. Enter the new user’s name in **User name** and the password in **User password**. Username can be up to 16 characters, and the password can have between 6 and 14 characters (at least one digit, no special characters). Click on **Add** to add the new user. The name of the new added user will be displayed in the **User name** drop-down menu under **Manage User**. There is a maximum of twenty user accounts.

Activate the boxes below to give privileges for functions:

- **I/O access**

This item supports fundamental functions that enable users to view the live video when accessing to the camera.

- **Camera control**

This item allows the appointed user to change camera parameters on the **Camera** and **Pan Tilt** setting page.

## Manage User

- **Delete user**

Pull down the **User name** drop-down menu and select the username that is wished to be deleted. Click on **Delete** to remove the selected name.

- **Edit user**

Pull down the **User name** drop-down menu and select the username. Click on **Edit** and a popup window will appear. In the appeared window, enter the new user password and reset the privileges. Click on **Save** to confirm the changes. Then click on **Close** to complete the editing.

## HTTP Authentication Setting

This setting allows secured connections between the IP camera and web browser by enforcing access controls to web resources. When users approach to the web browser, it'll ask for username and password, which protects the camera settings or live streaming information from snooping. There are two security models available: Basic and Digest. Refer to the descriptions below for more details.

- **Basic**

This mode can only provide basic protection for the connection security. There will still be risks for the password being intercepted.

- **Digest**

Digest mode is a safer option for protection. The password is sent in an encrypted format to prevent it from being stolen.

**NOTE!** Users MUST click on **Save** to apply the setting.

## Streaming Authentication Setting

This setting provides security against unauthorized users from getting streaming via Real Time Streaming Protocol (RTSP). If the setting is enabled, users will be requested to enter user name and password before viewing the live streams. There are three security modes available: Disable, Basic and Digest. Refer to the descriptions below for more details.

- **Disable**

If disable mode is selected, there will be no security provided to against unauthorized access. Users will not be asked to input user name and password for authentication.

- **Basic**

This mode can only provide basic protection for the live streams. There will still be risks for the password being intercepted.

- **Digest**

Digest mode is a safer option for protection. The password is sent in an encrypted format to prevent it from being stolen.

**NOTE!** Users MUST click on **Save** to apply the setting.

## Enable Account Lockout Function

The Account Lockout Function is to lock out an account when someone tries to log on unsuccessfully several times in a row. To protect user’s account, “Account Lockout Function” is activated when multiple login failures occur. Check the box **Enable Account Lockout Function** and enter the number of threshold and duration.

- **Threshold**

Threshold is a maximum number of login attempts, ranging from 5-20 times. The default value is 5 (attempts).

- **Duration**

Duration is the length of time that the account remains locked once the account lockout function is triggered, ranging from 1-60 minutes (default is 10 minutes).

## Auto Log Off Setting

If **Enable log off timer** is enabled, the camera will log off the current user after the specified number of minutes without interaction have passed (default is 5 minutes).

## HTTPS

To edit the HTTPS settings, select **System > Security > HTTPS**.

**HTTPS** allows secure connections between the camera and the web browser using **Secure Socket Layer (SSL)** or **Transport Layer Security (TLS)**, which protects camera settings and user-name/password information from snooping. It is required to install a self-signed or generated certificate or a CA-signed certificate for implementing HTTPS.

To use HTTPS on the camera, an HTTPS certificate must be installed. The HTTPS certificate can be obtained by either creating and sending a certificate request to a Certificate Authority (CA), by uploading a certificate, or by creating a self-signed HTTPS certificate.

**NOTE!** On MOBOTIX MOVE cameras, a certificate has already been installed. If you are not required to use a specific certificate (provided by your network administrator), you can use the pre-installed certificate.

## Enable HTTPS

Select HTTPS secure mode from the **Enable HTTPS** drop-down list. Once enabled, choose one of the following modes.

- **Disable**  
No security against unauthorized access. Users will not be asked to install new certificate.
- **HTTP & HTTPS**  
Under this mode, HTTP & HTTPS secure connections are enabled.
- **HTTPS only**  
Under this mode, the secure connection is ensured by HTTPS only.

Click on **Save** to apply and store the settings.

## Install new certificate

Pull down the **Install new certificate** drop-down list and select the certificate type. Choose one from the following types.

- **Generate Self-signed Certificate**  
Before a CA-issued certificate is obtained, you can create and install a self-signed certificate first.  
Beneath **Generate Self-signed Certificate**, click on **Create** and provide the requested information as outlined under [Provide the Certificate Information, p. 39](#).

**NOTE!** The self-signed certificate does not provide the same high level of security as when using a CA-issued certificate.

- **Generate Certificate Request**  
Click on **Generate Certificate Request** to create a certificate request for obtaining a signed certificate from CA. Provide the requested information as outlined under [Provide the Certificate Information, p. 39](#).  
When the request is complete, the subject of the created request will be shown in the field. Click on **Properties** below the **Subject** field, copy the PEM-formatted request and send it to the selected CA.  
When the signed certificate is returned, install it by uploading the signed certificate (see [Upload Private Key/Certificate, p. 39](#)).

## Upload Private Key/Certificate

- Do one of the following:
  - If you have a *private key* file, click on **Browse** beneath **Private key** and select the private key file.
  - If you have a *certificate* file, click on **Browse** beneath **Certificate** and select the certificate file.
- Click on **Upload** and wait until the installation is finished.

Click on **Save** to apply and store the settings.

## Provide the Certificate Information

To create a Self-signed HTTPS Certificate or a Certificate Request to CA, please enter the information as requested.

Information Item	Create Self Signed Certificate	Create Certificate Request
Country	✓	✓
State or Province	✓	✓
Locality	✓	✓
Organization	✓	✓
Organizational Unit	✓	✓
Common Name	✓	✓
Valid Days	✓	-

- **Country**  
enter a two-letter combination code to indicate the country the certificate will be used in. For instance, type in “US” to indicate United States.
- **State or Province**  
Enter the local administrative region.
- **Locality**  
Enter other geographical information.
- **Organization**  
Enter the name of the organization to which the entity identified in “Common Name” belongs.
- **Organization Unit**  
Enter the name of the organizational unit to which the entity identified in “Common Name” belongs.

- **Common Name**

Indicate the name of the person or other entity that the certificate identifies (often used to identify the website).

- **Valid Days**

Enter the period in days (1 to 9999) to indicate the valid period of certificate.

Click on **OK** to save the Certificate Information after completing the setting.

## IP Filter

To edit the IP filter settings, select **System > Security > IP Filter**.

With IP Filter, you can allow or deny specific IP addresses from accessing the camera.

### Enable IP Filter

Check the box to enable the IP Filter function. Once enabled, the listed IP addresses (IPv4) in the **Filtered IP Addresses** list box will be allowed/denied to access the camera.

Select **Allow** or **Deny** from the drop-down menu and click on **Apply** to determine the IP filter behavior.

### Add IP Address

Input IP address at the blank space below the **Filtered IP Address** list and click **Add**. The newly-added address will be shown in the list. Up to 256 IP address entries can be specified.

In addition, to filter a group of IP addresses, enter an address at the blank space followed with a slash and a number ranging from 1 to 31, e.g. 192.168.2.81/30. The number after the slash can define how many IP addresses will be filtered. For details, please refer to [Example: Filtering a Group of Consecutive IP Addresses](#), p. 40 below.

### Delete IP Address

To remove an IP address from the **Filtered IP Address** list, select the address and click on **Delete**.

### Example: Filtering a Group of Consecutive IP Addresses

1. Convert 192.168.2.81/30 to binary numbers (see [Appendix B: Converting IP Addresses from Decimal to Binary](#), p. 92). The binary numbers are 11000000.10101000.00000010.01010001. The number “30” after the slash is referring to the first 30 digits of the binary numbers.



2. Convert a few IP addresses before and after 192.168.2.81 to binary numbers. Then compare their first 30 digits with the binary numbers of 192.168.2.81.
  1. Convert 192.168.2.80 to binary numbers. The binary numbers are 11000000.10101000.00000010.01010000. The first 30 digits are the same with the binary numbers of 192.168.2.81, thus 192.168.2.80 will be filtered.
  2. Convert 192.168.2.79 to binary numbers. The binary numbers are 11000000.10101000.00000010.01001111. The first 30 digits are different with the binary numbers of 192.168.2.81, thus 192.168.2.79 will not be filtered. This also means the IP addresses before 192.168.2.79 will not be filtered. Therefore, you can stop converting the IP addresses before 192.168.2.79 to binary numbers.
  3. Repeat the same procedure in “a” with the IP addresses after 192.168.2.81. Stop when the situation occurs in “b” happened. Namely, the 30th digit of the binary numbers of IP address 192.168.2.84 is different, and will not be filtered.

As a result, the IP addresses 192.168.2.80 to 192.168.2.83 will be filtered when entering 192.168.2.81/30. The following table clearly shows the 30<sup>th</sup> digit of the binary numbers of IP addresses 192.168.79 and 192.168.84 are different from the others. Therefore, these two IP addresses will not be filtered.

IP Addresses	Binary Numbers
192.168.2.79	11000000.10101000.00000010.01001111
192.168.2.80	11000000.10101000.00000010.01010000
192.168.2.81	11000000.10101000.00000010.01010001
192.168.2.82	11000000.10101000.00000010.01010010
192.168.2.83	11000000.10101000.00000010.01010011
192.168.2.84	11000000.10101000.00000010.01010100

---

## IEEE 802.1X

To edit the IEEE 802.1x settings, select **System > Security > IEEE 802.1X**.

The camera is allowed to access a network protected by 802.1X/EAPOL (Extensible Authentication Protocol over LAN).

Choose **On** to enable the IEEE 802.1X function.

Select one among the four protocol types: **EAP-MD5**, **EAP-TLS**, **EAP-TTLS** and **EAP-PEAP**.

Users need to contact with the network administrator for gaining certificates, user IDs and passwords.

## CA Certificate

The CA certificate is created by the Certification Authority for the purpose of validating itself. Upload the certificate for checking the server’s identity.

## Client Certificate/Private Key

Upload the Client Certificate and Private Key for authenticating the camera itself.

## Settings

- **Identity**

Enter the user identity associated with the certificate. Up to 16 characters can be used.

- **Private Key Password**

Enter the password (maximum 16 characters) for user identity.

## Enable IEEE 802.1X

Check the box to enable IEEE 802.1X.

Click on **Save** to apply and store the settings.

# Network

To edit the network settings, select **System > Network**.

Click on **Network**, there will be a drop-down menu with tabs including **Basic**, **QoS**, **VLAN**, **SNMP**, and **UPnP**.

## Basic

To edit the basic settings, select **System > Network > Basic**.

This setting page is for setting a new IP address for the camera, configuring other network-related parameters and activating IPv6 address (if the network supports it).

## General

This setting menu is for configuring a new IP address for the camera. To setup an IP address, please find out the network type first. Contact the network provider for it. Then refer to the network type and follow the instructions to setup the IP address.

**NOTE!** If the network type is Point-to-Point Protocol over Ethernet (PPPoE), please obtain the PPPoE username and password from the network provider.

- **Get IP address automatically (DHCP)**

**NOTE!** You should copy the camera’s MAC address, which can be found on the label or on the package container of the camera. You will need the MAC address to obtain the IP address later on.

Select the item and click **Save** to confirm the new setting. A note for camera system reboot will appear. Click **OK** and the camera system will restart with a new IP address.

Check the network router or DHCP server to find the new IP address. If you cannot access the router or DHCP server, please contact your network administrator with a list of MAC addresses to fill in the corresponding IP addresses.

- **Use fixed IP address**

Select the item and insert the new IP address, e.g. 192.168.7.123. Note that the inserted IP address should be in the same LAN as the PC’s IP address. Then go to the Default gateway (explained later) blank and change the setting, e.g. 192.168.7.254. Click on **Save** to confirm the new setting. A note for system restart will appear, click **OK** and the camera system will restart. Wait for 15 seconds. The camera’s IP address in the URL bar will be changed, and users have to login again.

When using a static IP address to connect the camera, you can access the camera by inputting the IP address in the URL bar and hit **Enter** on the keyboard.

- **Use PPPoE**

For the PPPoE users, enter the PPPoE username and password into the enter fields.

Click on **Save** to apply and store the settings.

## Advanced

The following introduces the camera’s Web Server port, RTSP port, MJPEG over HTTP port, and HTTPS port.

- **Web Server port**

The default web server port is 80. With the default web server port ‘80’, you can simply input the IP address of the camera in the URL bar of a web browser to connect the camera. When the web server port is changed to any number other than 80, users have to enter the camera’s IP address followed by a colon and the port number. For instance, a camera whose IP address is set as 192.168.0.100 and web server port as 8080 can be connected by entering “http://192.168.0.100:8080” in the URL bar.

- **RTSP port**

The default setting of RTSP Port is 554; the RTSP Port should be set as 554 or from the range 1024 to 65535.

- **MJPEG over HTTP port**

This setting always uses port 80. To access the MJPEG stream over HTTP, open `http://<ip address>/live/stream<#>`, where <#> is the number of the stream you want to show.

- **HTTPS port**

The default setting of HTTPS Port is 443; the HTTPS Port should be set as 443 or from the range 1024 to 65535.

**NOTE!** Please make sure the port numbers set above are not the same with each other; otherwise, network conflict may occur.

- **RTSP URL**

When users use RTSP players to view the live streaming, the camera provides the flexibility to configure the streaming access name for stream 1 to stream 4. The streaming format is `rtsp://ip address:rtsp port/access name`. Take a camera whose IP address is set as 192.168.0.100 for example, if users enter “liveview.1” in the blank of stream 1 access name, the streaming address of stream 1 will be `rtsp://192.168.0.100:554/liveview.1`.

**NOTE!** The maximum length of the access name is 32 characters, and the valid characters are "A-Za-z0-9" and "!#\$%&'-.@^\_~".

**NOTE!** For a list of default ports, please refer to [Appendix C: List of Open/Closed IP Ports, p. 94](#).

Click on **Save** to apply and store the settings.

## IPv6 Address Configuration

If the network supports IPv6, you can check the box beside **Enable IPv6** and click **Save**. An IPv6 address will appear beside **Address**, and you can use it to connect to the camera.

Click on **Save** to apply and store the settings.

## QoS

To edit the QoS (*Quality of Service*) settings, select **System > Network > QoS**.

QoS allows providing differentiated service levels for different types of traffic packets, which guarantees delivery of priority services especially when network congestion occurs. Adapting the Differentiated Services (DiffServ) model, traffic flows are classified and marked with DSCP (DiffServ CodePoint) values, and thus receive the corresponding forwarding treatment from DiffServ capable routers.

## DSCP Settings

The DSCP value range is from 0 to 63. The default DSCP value is 0 (DSCP disabled). The camera uses the following QoS Classes:

- **Management DSCP**

**NOTE!** The class consists of HTTP traffic: Web browsing.

- **Stream 1~4 DSCP**

**NOTE!** You can set the Video DSCP of each stream.

- **Video DSCP**

The class consists of applications such as MJPEG over HTTP, RTP/RTSP and RTSP/HTTP.

**NOTE!** To enable this function, please make sure the switches/routers in the network support QoS.

Click on **Save** to apply and store the settings.

## VLAN

To edit the VLAN settings, select **System > Network > VLAN**.

Check the box **Enable VLAN** to activate the VLAN function. Enter the VLAN ID. The allowed range of VLAN ID is from 1 to 4095. The default value is 20.

## CoS

CoS stands for *Class of Service*. The higher the value of CoS is, the better transmission performance will be. The value also determines the transmission priority among the following three classes:

- **Live Video**

The value range is from 0 to 7.

- **Management**

The value range is from 0 to 7.

## SNMP

To edit the SNMP (Simple Network Management Protocol) settings, select **System > Network > SNMP**.

With Simple Network Management Protocol (SNMP) support, the camera can be monitored and managed remotely by the network management system.

## SNMP v1/v2

- **Enable SNMP v1/v2**

Select the version of SNMP to use by checking the box.

- **Read Community**

Specify the community name that has read-only access to all supported SNMP objects. The default value is “public”.

- **Write Community**

Specify the community name that has read/write access to all supported SNMP objects (except read-only objects). The default value is “private”.

## SNMP v3

SNMP v3 supports an enhanced security system that provides protection against unauthorized users and ensures the privacy of the messages. Users will be requested to enter security name, authentication password and encryption password while setting the camera connections in the network management system. With SNMP v3, the messages sent between the cameras and the network management system will be encrypted to ensure privacy.

- **Enable SNMP v3**

Enable SNMP v3 by checking the box.

- **Security Name**

The maximum length of the security name is 32 characters.

**NOTE!** The valid characters are "A-Za-z0-9" and "!#\$%&'-.@^\_~".

- **Authentication Type**

There are two authentication types available: MD5 and SHA. Select **SHA** for a higher security level.

- **Authentication Password**

The authentication password must be 8 characters or more. The input characters will be displayed as dots for security purposes.

**NOTE!** The valid characters are "A-Za-z0-9" and "!#\$%&'-.@^\_~".

- **Encryption Type**

There are two encryption types available: DES and AES. Select **AES** for a higher security level.

- **Encryption Password**

The minimum length of the encryption password is 8 characters and the maximum length is 512 characters. The input characters will be displayed as dots for security purposes. The encryption password can also be left blank. However, the messages will not be encrypted to protect privacy.

**NOTE!** The valid characters are "A-Za-z0-9" and "!#\$%&'-.@^\_~".

## Traps for SNMP v1/v2/v3

Traps are used by the camera to send messages to a management system for important events or status changes.

- **Enable Traps**

Check the box to activate trap reporting.

- **Trap address**

Enter the IP address of the management server.

- **Trap community**

Enter the community to use when sending a trap message to the management system.

## Trap Option

- **Warm Start**

A Warm Start SNMP trap signifies that the SNMP device, i.e. IP camera, performs software reload.

Click on **Save** to apply and store the settings.

## UPnP

To edit the UPnP settings, select **System > Network > UPnP**.

## UPnP Setting

- **Enable UPnP**

When the UPnP is enabled, whenever the camera is presented to the LAN, the icon of the connected cameras will appear in My Network Places to allow for direct access.

**NOTE!** To enable this function, please make sure the UPnP component is installed on the computer. Please see [Appendix A: Installing UPnP Components, p. 92](#) for the installation procedure.

- **Enable UPnP port forwarding**

When the UPnP port forwarding is enabled, the camera is allowed to open the web server port on the router automatically.

**NOTE!** To enable this function, please make sure that the router supports UPnP and it is activated.

- **Friendly name**

Set a name for the camera for identity.

Click on **Save** to apply and store the settings.

## OpenVPN

This camera uses [OpenVPN](#) to implement a virtual private network (VPN). A VPN establishes secure point-to-point or site-to-site connections between networks and computers (e.g. for remote workers). Your VPN gateway administrator will provide the values for the settings below.

- **OpenVPN**

Select **Enabled** to activate VPN.

- **Server address**

Enter the IP address or DNS name of the VPN gateway you want to use.

- **Server port**

Enter the server port of the specified VPN gateway.

- **Communication protocol**

Select the type of protocol for the specified VPN gateway.

- **Cipher**

Select the cipher that is being used to encode the network data.

- **CA certificate**

Click on **Browse** to upload a new certification authority (CA) certificate file (ask your VPN administrator for details).

- **Client certificate**

Click on **Browse** to upload a new client certificate file (ask your VPN administrator for details).

- **Private key**

Click on **Browse** to upload a new private key file (ask your VPN administrator for details).

Click on **Save** to apply and store the settings.



## Bonjour

Bonjour (also known as [Zero-configuration networking](#) or *zeroconf*) is a method for establishing automatic peer-to-peer networks (i.e. without dedicated network services, such as DHCP or DNS servers).

Activate **Enable Bonjour** to use this feature.

Click on **Save** to apply and store the settings.

## DDNS

To edit the DDNS settings, select **System > DDNS**.

Dynamic Domain Name System (DDNS) allows a host name to be constantly synchronized with a dynamic IP address. In other words, it allows those using a dynamic IP address to be associated to a static domain name so others can connect to it by name.

- **Enable DDNS**

Check the item to enable DDNS.

- **Provider**

Select one DDNS host from the provider list.

- **Host name**

Enter the registered domain name in the field.

- **Username/E-Mail**

Enter the username or E-mail required by the DDNS provider for authentication.

- **Password/Key**

Enter the password or key required by the DDNS provider for authentication.

## Mail

To edit the mail settings, select **System > Mail**.

The administrator can send an E-mail via Simple Mail Transfer Protocol (SMTP) when an alarm is triggered. SMTP is a protocol for sending E-mail messages between servers. SMTP is a relatively simple, text-based protocol, where one or more recipients of a message are specified and the message text is transferred.

Two sets of SMTP can be configured. Each set includes SMTP Server, Account Name, Password and E-mail Address settings. For SMTP server, contact the network service provider for more specific information.

Click on **Save** when finished. Then, please click on **Test** to check the connection between the camera and the specified SMTP server.

## FTP

To edit the FTP settings, select **System > FTP**.

The administrator can set the camera to send the alarm messages to a specific File Transfer Protocol (FTP) site when an alarm is triggered. You can assign alarm message to up to two FTP sites. Enter the FTP details, which include server, server port, username, password and remote folder, in the fields.

Click on **Save** when finished. Then, please click on **Test** to check the connection between the camera and the specified FTP server.

## HTTP

To edit the HTTP settings, select **System > HTTP**.

An HTTP Notification server can listen for the notification messages from the cameras by triggered events. Enter the HTTP details, which include server name (for instance, <http://192.168.0.100/admin.php>), username, and password in the fields. **Alarm** triggered and **Motion Detection** notifications can be sent to the specified HTTP server.

Click on **Save** to apply and store the settings.

**NOTE!** Please see **Events > Application > Send HTTP Notification, p. 54** for the HTTP notification settings.

## Events (Alarm Settings)

To edit the events settings, select **System > Events**. You will see these sections:

- **Application**
- **Motion Detection**
- **Network Failure Detection**
- **Periodical Event**
- **Manual Trigger**

## Triggered Actions (Common to All Event Types)

The following alarm actions can be triggered by the camera when it detects the corresponding event.

**NOTE!** Depending on the camera’s features and specific settings, some actions may not be available (e.g. FTP is only available if an FTP site has been specified).

- **Enable Alarm Output (high/low)**

Select these items to enable alarm relay outputs.

- **IR Cut Filter**

Select the item and the IR cut filter (ICR) of the camera will be removed (on) or blocked (off) when alarm input is triggered. This function is only available for models with IR cut filter.

**NOTE!** The [IR Function, p. 85](#) could not be set as **Auto** mode if this triggered action is enabled.

- **Send Alarm Message by FTP/E-Mail**

The administrator can select whether to send an alarm message by FTP and/or E-mail when audio is detected.

#### ■ Upload Image by FTP

Select this item and the administrator can assign an FTP site and configure various parameters. When audio is detected, event images will be uploaded to the appointed FTP site. Note that to implement this function, one of the streaming MUST be set as MJPEG; otherwise, this function will be grayed out and cannot be accessed.

The **Pre-trigger buffer** function allows users to check what happened to cause the trigger. The **Pre-trigger buffer** frame rate could be pre-determined. On the other hand, **Post-trigger buffer** is for users to upload certain amount of images after audio event occurs.

**NOTE!** The **Pre-trigger buffer** generally ranges from 1 to 20 frames. However, the range will change accordingly if the frame rate of MJPEG on **Streaming > Video Configuration** is 6 or lower.

Check the box **Continue image upload** to upload the triggered images during certain time or keep uploading until the trigger is off. Select **Upload for \_\_sec** and enter the duration in the blank. The images of the duration will be uploaded to FTP when the audio event occurs. The setting range is from 1 to 99999 sec. Select **Upload while the trigger is active** to make the images keep being uploaded to FTP during the trigger active until the event stops. Set the Image frequency as the upload frame rate. The setting range is from 1 to 15 frames per second.

**NOTE!** Make sure FTP configuration has been completed. Refer to section FTP for further details.

#### ■ Upload Image by E-Mail

Select this item and the administrator can assign an E-mail address and configure various parameters. When audio is detected, event images will be sent to the appointed E-mail address. Note that to implement this function, one of the streaming MUST be set as MJPEG; otherwise, this function will be grayed out and cannot be accessed.

The **Pre-trigger buffer** function allows users to check what happened to cause the trigger. The **Pre-trigger buffer** frame rate could be pre-determined. On the other hand, **Post-trigger buffer** is for users to upload certain amount of images after the audio event occurs.

**NOTE!** The **Pre-trigger buffer** generally ranges from 1 to 20 frames. However, the range will change accordingly if the frame rate of MJPEG on **Streaming > Video Configuration** is 6 or lower.

Check the box **Continue image upload** to upload the triggered images during certain time or keep uploading until the trigger is off. Select **Upload for \_\_sec** and enter the duration in the blank. The images of the duration will be uploading by E-mail when the audio event occurs. The setting range is from 1 to 99999 sec. Select **Upload while the trigger is active** to make the images keep being uploaded to E-mail during the trigger active until the event stops. Set the Image frequency as the upload frame rate. The setting range is from 1 to 15 frames per second.

**NOTE!** Make sure SMTP configuration has been completed. Refer to section Mail for further details.

#### ■ Upload Image to SD Card

Select this item, and then the images will be uploaded to the SD card periodically. Note that to implement this function, one of the streaming MUST be set as MJPEG; otherwise, this function will be grayed out and cannot be accessed.

The **Pre-trigger buffer** function can define how many images to be uploaded before the triggered moment. The **Post-trigger buffer** function can define how many images to be uploaded after the triggered moment.

**NOTE!** The **Pre-trigger buffer** generally ranges from 1 to 20 frames. However, the range will change accordingly if the frame rate of MJPEG on **Streaming > Video Configuration** is 6 or lower.

**NOTE!** Before implementing **Upload Image to SD Card**, please make sure that the SD Card is properly detected and installed. Refer to **Storage Management > SD Card > Device Information** for further details.

#### ■ **Send HTTP Notification**

Check this item, select the destination HTTP address, and specify the parameters for event notifications by **Audio Detection** triggered. When an alarm is triggered, the notification can be sent to the specified HTTP server.

For instance, if the custom parameter is set as “action=1&group=2”, and the HTTP server name is “http://192.168.0.1/admin.php”, the notification will be sent to HTTP server as “http://192.168.0.1/admin.php? action=1&group=2” when alarm is triggered.

#### ■ **Record Video Clip**

Check this item and select a video recording storage type, **SD Card** or **NAS** (Network-Attached Storage>. The Audio Detection recording will be stored in microSD/SD card or the NAS when audio is detected.

The **Pre-trigger buffer** recording function allows users to check what happened to cause the trigger. The pre-trigger buffer time range is from 1 to 3 sec. Select **Upload for \_\_ sec** to set the recording duration after audio is triggered. The setting range is from 1 to 99999 sec. Select **Upload while the trigger is active** to record the triggered video until the trigger is off.

**NOTE!** Please make sure the local recording (with microSD/SD card) or the remote recording (with NAS) is activated so that this function can be implemented. Refer to section Recording for further details.

## File Name

Enter a file name in the blank, e.g. image.jpg. The uploaded image’s file name format can be set in this section. Please select the one that meets the requirements.

#### ■ **Add date/time suffix**

File name: imageYYMMDD\_HHNNSS\_XX.jpg

Y: Year, M: Month, D: Day

H: Hour, N: Minute, S: Second

X: Sequence Number

#### ■ **Add sequence number suffix (no maximum value)**

File name: imageXXXXXXXXX.jpg

X: Sequence Number

#### ■ **Add sequence number suffix up to # and then start over**

File Name: imageXX.jpg

X: Sequence Number

**NOTE!** The file name suffix will end at the number being set. For example, if the setting is up to “10”, the file name will start from 00, end at 10, and then start all over again.

- **Overwrite**

The original image in the FTP site will be overwritten by the new uploaded file with a static file name.

Click on **Save** to apply and store the settings.

## Application

To edit the application settings, select **System > Events > Application**.

The camera supports one alarm input and one relay output for cooperation with alarm system to catch event images. Refer to alarm pin definition below to connect alarm devices to the camera if needed.

### Alarm Switch

The default setting for the Alarm Switch function is **Off**. Enable the function by selecting **On**. You can also activate the function according to the schedule previously set in the **Schedule** setting page. Select **By schedule** and click **Please select...** to choose the desired schedule from the drop-down menu.

### Alarm Type

Select an alarm type, **Normal close** or **Normal open**, that corresponds with the alarm application.

### Triggered Action

See the section [Triggered Actions \(Common to All Event Types\)](#), p. 51 for information about the various actions that can be triggered.

Click on **Save** to apply and store the settings.

## Motion Detection

To edit the motion detection settings, select **System > Events > Motion Detection**.

Motion Detection function allows the camera to detect suspicious motion and trigger alarms by comparing sampling pixels in the detection area of two consecutive live images. When motion volume in the detection area reaches/exceeds the determined sensitivity threshold value, the alarm will be triggered.

The function supports up to 4 sets of Motion Detection Settings. Settings can be chosen from the Motion Detection drop-down menu.

### Motion Detection

By default, motion detection is **Off**. Select **On** to enable this feature.

## Menu Reference

### The “System” Tab

---

You can also activate the function according to the schedule previously set in the **Schedule** setting page. Select **By schedule** and click **Please select...** to choose the desired schedule from the drop-down menu.

### Motion Region Paint

The camera divides the detection area into 1200 (40x30) detection grids; you can draw the motion detection region using the paintbrush.

Check the box **Enable brush** and select the brush size, 1x1, 3x3 or 5x5. Then, left click and drag the mouse cursor to draw the preferred detection region. To erase the drawn detection region, left click and drag the mouse cursor on the colored grids.



### Motion Detection Setting

Users could adjust various parameters of Motion Detection in this section.



■ **Sampling pixel interval [1-10]:**

This item is used to examine the differences between two frames. You can configure the interval of sampling pixel. The default value is 1. For instance, if users set the interval as 3, IP camera system will take one sampling pixel from every 3 pixels of each row and each column in detection area (refer to the figure below). The alarm will be triggered when differences are detected.

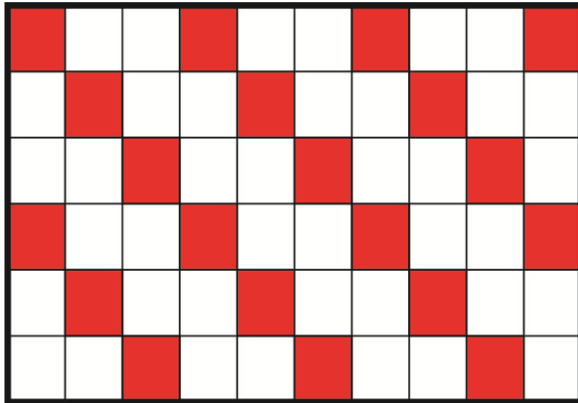

■ **Detection level [1-100]:**

You can configure detection level for each sampling pixel. Detection level is how much the camera can accept the differences between two sampling pixels. The smaller the value is, the more minor motions it detects. The default level is 10.

■ **Sensitivity level [1-100]:**

The default level is 80, which means if 20% or more sampling pixels are detected differently, system will detect motion. The bigger the value, the more sensitive it is. Meanwhile, when the value is bigger, the red horizontal line in the motion indication window will be lower accordingly.

■ **Time interval (sec) [0-7200]:**

The value is the interval between each detected motion. The default interval is 10.

## Motion Indication Bar

When Motion Detection function is activated and the motion is detected, the signals will be displayed on the motion indication bar. The motion indication bar will go green or red when there is any motion occurrence in the detection region.

Green suggests the occurring motion is detected and does not exceed the threshold of detection level and sensitivity level. No alarms will be triggered.



Red suggests the ongoing motion exceeds the threshold of detection level and sensitivity level. The alarm will be triggered.

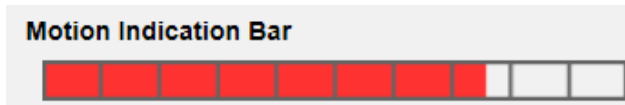

### Triggered Action

See the section [Triggered Actions \(Common to All Event Types\)](#), p. 51 for information about the various actions that can be triggered.

Click on **Save** to apply and store the settings.

## Network Failure Detection

To edit the network failure detection settings, select **System > Events > Network Failure Detection**.

Network Failure Detection allows the camera to ping another IP device (e.g. NVR, VSS, Video Server, etc.) within the network periodically and generates some actions in case of network failure occurs, for instance, a Video Server is somehow disconnected.

Being capable of implementing local recording (through microSD/SD card) or remote recording (via NAS) when network failure happens, the camera can be a backup recording device for the surveillance system.

### Detection Switch

The default setting for the Detection Switch function is **Off**. Enable the function by selecting **On**. You can also activate the function according to the schedule time that is previously set in the **Schedule** setting page. Select **By schedule** and click **Please select...** to choose the desired schedule from the drop-down menu.

### Detection Type

Input the IP device address and the period of ping time to ping. The camera will ping the IP device every N minute(s). If it fails for up to three times, the alarm will be triggered. The ping time setting range is from 1 to 99 min.

### Triggered Action

See the section [Triggered Actions \(Common to All Event Types\)](#), p. 51 for information about the various actions that can be triggered.

Click on **Save** to apply and store the settings.

## Periodical Event

To edit the periodical event settings, select **System > Events > Periodical Event**.

With Periodical Event setting, you can set the camera to upload images periodically to an FTP site or an E-mail address. For example, if the time interval is set to 60 seconds, the camera will upload images to the FTP site or the E-mail address every 60 seconds. The images to be uploaded are the images before and after the triggered moment. You can define how many images to be uploaded in the **Triggered Action** section of this setting page.

## Periodical Event

The default setting for the Periodical Event function is **Off**. Enable the function by selecting **On**.

## Time Interval

The default value of the time interval is 60 seconds. The setting range of the time interval is from 60 to 3600 seconds.

## Triggered Action

See the section [Triggered Actions \(Common to All Event Types\)](#), p. 51 for information about the various actions that can be triggered.

Click on **Save** to apply and store the settings.

## Manual Trigger

To edit the manual trigger settings, select **System > Events > Manual Trigger**.

With Manual Trigger setting, the current image(s) or video can be uploaded to the appointed destination, such as an FTP site or an E-mail address. The administrator can specify the triggered actions that will take when the users switch the Manual Trigger button to ON. All options are listed as follows.

## Manual Trigger

The default setting for the Manual Trigger function is **Off**. Enable the function by selecting **On**. After the Manual Trigger function is enabled, click the Manual Trigger button on the Home page to start uploading data. Click again to stop uploading.

## Triggered Action

See the section [Triggered Actions \(Common to All Event Types\)](#), p. 51 for information about the various actions that can be triggered.

Click on **Save** to apply and store the settings.

## Storage Management

To edit the storage management settings, select **System > Storage Management**.

---

Click on **Storage Management**, there will be a drop-down menu with tabs including **SD Card** and **Network Share**.

## SD Card

To edit the settings for the SD card, select **System > Storage Management > SD Card**.

You can implement local recording to the microSD/SDHC/SDXC card with up to 1 TB capacity.

This page shows the capacity information of the storage medium and a recording list with all the recording files saved on the memory card. You can also format the storage medium and implement automatic recording cleanup through the setting page.

To implement recording on a storage medium, please go to the **Recording** page (see [Recording](#), p. 63).

**NOTE!** Please format the storage medium when using it for the first time. Formatting will also be required when a storage medium is being used on one camera and later transferred to another camera with different software platform.

It is not recommended to record on microSD/SD cards for 24/7 continuously, as it may not be able to support long term continuous data read/write. Please contact the manufacturer of the microSD/SD card for information regarding reliability and life expectancy.

## Device Information

After the storage medium is inserted into the camera, the card information such as memory capacity and status will be shown at **Device Information**.

## Recording Source

Select a video stream to set as the recording source. The default format of the video stream is **Stream 1**. Select a preferred stream from the drop-down list.

Click on **Save** to apply and store the settings.

## Recording Filename Format

Select a format as the recording file name format. The default recording file name format is **Start time only**. Select a preferred format from the drop-down list.

Click on **Save** to apply and store the settings.

## Device Setting

Click on **Format** to format the storage medium.

Two file systems are provided: **vfat** (default) and **ext4**. It is recommended to select **ext4** for steady and better performance.

## Disk Cleanup Setting

Check **Enable automatic disk cleanup** and specify the time **1~999 day(s) or 1~142 week(s)** and storage limits **1~99% full** to configure disk cleanup settings.

Click on **Save** to apply and store the settings.

## Recording List

Enter the period in the date fields and click on **Search**. Select **Video / JPEG**, and then each video/image file on the storage medium will be listed in the recording list. The maximum file size is 60 MB/per file.

When the recording mode is set as **Always** (consecutive recording) and the storage medium recording is also allowed to be enabled by events triggered, once events occur, the system will immediately implement events recording to the memory card. After the recording of the events are finished, the camera will return to the regular recording mode.

- **Remove**

To remove a file, select the file first, and then click **Remove** button.

- **Sort**

Click on **Sort**, and the files in the Recording list will be listed in name and date order.

The capital letter at the beginning of a name indicates the type of recording:

Initial	Recording Type	Initial	Recording Type
A	Alarm	S	Periodical Event
M	Motion	R	Regular Recording
N	Network Failure	V	Manual Trigger
T	Tampering	U	Audio Detection

- **Download**

To open/download a video clip/image, select the file first, then click on **Download** below the **Recording** list. The selected file window will pop up. Click on the AVI/JPEG file to download the file to the specified location.

## Network Share (NAS)

To edit the network share settings, select **System > Storage Management > Network Share**.

You can store the recording videos to a network share folder, or NAS (Network-Attached Storage). A NAS device is used for data storage and data sharing via network. This page displays the capacity information of the network device and a recording list with all the recording files saved on the net-

work device. You can also format the NAS and implement automatic recording cleanup through the setting page.

### Device Information

When a NAS is successfully installed, the device information such as the memory capacity and status will be shown at **Device Information**.

### Storage Setting

The administrator can set the camera to send the alarm messages to a specific NAS site when an alarm is triggered. Enter the network device details, which include host (the IP of the NAS), share (the folder name of the NAS), user name, and password, in the fields.

Click on **Save** to apply and store the settings.

### Storage Tools

Click on **Format** to format the NAS.

### Recording Source

Select a video stream to set as the recording source. The default format of the video stream is **Stream 1**. Select a preferred stream from the drop-down list.

Click on **Save** to apply and store the settings.

### Recording Filename Format

Select a format to set as the recording file name format. The default recording file name format is **Start time only**. Select a preferred format from the drop-down list

Click on **Save** to apply and store the settings.

### Disk Cleanup Setting

Check **Enable automatic disk cleanup** and specify the time **1~999 day(s) or 1~142 week(s)** and storage limits **1~99% full** to configure disk cleanup settings.

Click on **Save** to confirm the settings.

### Recording List

Each video file on the Network Share will be listed in the Recording list. The maximum file size is 60 MB/per file.

When the recording mode is set as **Always** (consecutive recording) and the NAS recording is also allowed to be enabled by events triggered, once events occur, the system will immediately implement events recording to NAS. After the recording of the events are finished, the camera will return to the regular recording mode.

■ **Remove**

To remove a file, select the file first, and then click on **Remove**.

■ **Sort**

Click on **Sort**, and the files in the Recording list will be listed in name and date order.

The capital letter at the beginning of a name indicates the type of recording:

Initial	Recording Type	Initial	Recording Type
A	Alarm	S	Periodical Event
M	Motion	R	Regular Recording
N	Network Failure	V	Manual Trigger
T	Tampering	U	Audio Detection

■ **Download**

To open/download a video clip, select the file first, and then click on **download** below the Recording list field. The selected file window will pop up. Click on the AVI file to directly play the video in the player or download it to a specified location.

## Recording

To edit the recording settings, select **System > Recording**.

In the **Recording** setting page, you can specify the recording schedule that fits the present surveillance requirement.

**Recording**

**Recording Storage**

SD Card  
 Network Share

**Recording Schedule**

Disable  
 Always  
 Only during time frame

	Weekday	Start time	Duration
1	○ - - - - ○	00:00	24:00
2	- - - - -	----	----
3	- - - - -	----	----
4	- - - - -	----	----
5	- - - - -	----	----
6	- - - - -	----	----
7	- - - - -	----	----
8	- - - - -	----	----
9	- - - - -	----	----
10	- - - - -	----	----

Sun  Mon  Tue  Wed  Thu  Fri  Sat

Start time:  Duration:

## Recording Selector

Select *Camera 1* to *Camera 4* from the drop-down menu to configure the video stream from the corresponding camera head.

## Recording Storage

Select **SD Card** or **Network Share** as recording storage.

## Enable Recording Schedule

Two types of schedule mode are offered: **Always** and **Only during time frame**. You can select **Always** to activate recording on a storage medium or network storage all the time. Or, select a set of schedule from the time frame blank, check specific weekdays and setup the start time (hour:minute) and time period (hour:minute) to activate the recording at certain time frames. The setting range for the duration time is from 00:00 to 168:59.

Click on **Save** to apply and store the settings.

To delete a schedule, select one from the schedule list, and click **Delete**.

## Disable Recording Schedule

- Select **Disable** to terminate the recording function.
- Click on **Save** to apply and store the settings.

## Schedule

To edit the schedule settings, select **System > Schedule**.



	Weekday	Start time	Duration
1	<input type="radio"/> - - - - - <input type="radio"/>	day	----
2	- <input type="radio"/> <input type="radio"/> - - - -	06:00	12:00
3	- - - - -	----	----
4	- - - - -	----	----
5	- - - - -	----	----
6	- - - - -	----	----
7	- - - - -	----	----
8	- - - - -	----	----
9	- - - - -	----	----
10	- - - - -	----	----

Sun  Mon  Tue  Wed  Thu  Fri  Sat

Day  
 Night  
 Time

Start time : 06:00      Duration : 12:00

Save    Delete

## Schedules Setup

1. Select a time frame from the time frame list.
2. Check the weekday boxes below to choose the specific weekdays.
3. Select a time mode, Day, Night or Time. Under Time mode, specify the start time (hour:minute) and the time duration (hour:minute) to activate the schedule triggered features. The setting range for the time duration is from 00:00 to 168:59.
4. Click on **Save** to apply and store the settings.  
Alternatively, click on **Delete** to remove the highlighted time frame.

## Time Mode

### ▪ Day

The camera profile will be loaded when IR cut filter is on.

### ▪ Night

The camera profile will be loaded when IR cut filter is off.

### ▪ Time

This indicates the start time and the time duration for the schedule.

**NOTE!** Users MUST select **By schedule** under each feature setting page to enable the schedule function.

## File Location (Snapshots and Web Recording)

To edit the file location settings, select **System > File Location**.

You can specify a storage location on the PC or in the hard drive for the snapshots and the live video recordings. The default setting is: C:\. Once the setting is confirmed, click on **Save**, and all the snapshots and the web recordings will be saved in the designate location.

**NOTE!** Make sure the selected file path contains valid characters such as letters and numbers.

## View Information

To edit the view information settings, select **System > View Information**.

Click on **View Information**, there will be a drop-down menu with tabs including **Log File**, **User Information**, and **Parameters**.

### Log File

To edit the log file settings, select **System > View Information > Log File**.

Click on the tab to view the system log file. The camera keeps a record of the system’s behavior and information related to the camera. These log data can be exported for future use. Click **generate system log** and the Save File As dialog window will pop up. The default file name is named after the model name and the MAC address as “Model Name-MAC-log.tgz”. Select the file destination and click **Save** to export the log data.

**NOTE!** “Save File As” dialog window may not show up immediately for the camera needs some time to process the log data.

## User Information

To edit the user information settings, select **System > View Information > User Information**.

The administrator can view the privileges of each user (refer to [Security, p. 35](#)). User lines follow this syntax:

```
<User name>: <I/O access>:<camera control>:<talk>:<listen>
```

Example: <main-entrance>: 1:1:0:1

Values for <I/O access>, <camera control>, <talk>, and <listen>:

- 1: function allowed
- 0: function blocked

**NOTE!** The talk and listen privileges will be set regardless of the audio capabilities of the camera.

## Parameters

To edit the parameters settings, select **System > View Information > Parameter**.

Click on this item to view the parameter settings of the entire system, such as Camera Settings, Mask Information and Network Information.

## Factory Default

To edit the factory default settings, select **System > Factory Default**.

You can follow the instructions on this page to reset the camera to factory default settings if needed.

## Full Restore

Click on **Full Restore** to recall the factory default settings. The camera system will restart in 30 seconds. The IP address will be restored to default. After the camera system is restarted, reconnect the camera using the default IP address. The default IP address is 192.168.0.250.

## Partial Restore

Click on **Partial Restore** to recall the factory default settings (excluding network settings). The camera system will restart in 30 seconds. Refresh the browser page after the camera system is restarted.

**NOTE!** The IP address will not be restored to default.

## Reboot

Click on **Reboot** and the camera system will restart without changing the current settings. Refresh the browser page after the camera system is restarted.

## Software Version

To see the software version, select **System > Software Version**.

## Software Upgrade

To edit the software upgrade settings, select **System > Software Upgrade**.

**NOTE!** Make sure the upgrade software file is available before carrying out software upgrade.

The procedure of software upgrade is as below.

1. Click on **Browse** and locate the upgrade file, for example, “ulmage\_userland”.

**NOTE!** Do not change the name of the upgrade file, or the system will fail to find the file.

2. Pick a file type from the drop-down menu. In this case, select “ulmage+userland.img”.
3. Click on **Upgrade**. Then the system will prepare to start the software upgrade. Subsequently, an upgrade status bar will be displayed on the page to show the current upgrade process. After the upgrade process is finished, the viewer will return to the **Home** page.
4. Close the video browser.
5. Click on **Start** and activate the **Control Panel**. In the appeared window, double-click on **Add or Remove Programs**. A window with the **Currently install programs** list will pop up. In the list, select the viewer and click on **Remove** to uninstall the existing program.
6. Open a new web browser and re-login the camera. Users will be prompted to download the viewer. Once the viewer is downloaded and installed, the live video will be available.

## Maintenance

To edit the maintenance settings, select **System > Maintenance**.

You can export configuration files to a specified location and retrieve data by uploading the configuration file to the camera.

### Export Files

You can save the system settings by exporting a configuration file (.bin) to a specified location for future use. Click on **Export**, and the popup File Download window will come out. Click on **Save** and specify a desired location for saving the configuration file.

### Upload Files

To upload a configuration file to the camera, click on **Browse** to select the configuration file and then click on **Upload** for uploading.

# The “Streaming” Tab

To edit the video configuration settings, select **Streaming > Video Configuration**.

The screenshot displays the MOBOTIXMOVE interface for the Video Configuration page. The top navigation bar includes 'Home', 'System', 'Streaming' (highlighted), 'Camera', and 'Logout'. A language dropdown is set to 'English'. A left sidebar lists various configuration options, with 'Video Configuration' selected. The main content area is titled 'Video Configuration' and contains two sections for 'stream 1' and 'stream 2'. Each stream section includes dropdown menus for 'Encoding' (Yes), 'Encode Type' (H.264), 'Resolution' (1920 x 1080), and 'Rate Control' (VBR). To the right of these are a 'Profile' dropdown (Main profile), a 'Framerate' slider (30), a 'Bitrate' slider (4096), and a 'GOV Length' slider (60). At the bottom right of the configuration area are 'Save' and 'Reset' buttons.

## NOTE!

- Only the administrator can access the **Streaming** configuration page.
- The preset resolution and other settings will vary depending on the current camera model.

## Video Configuration

To edit the video configuration, select **Streaming > Video Configuration**.

### Encoding

For **stream 2** to **stream 4**, select **Yes** to enable a stream and **No** to disable it.

## Encode Type

The available video resolution formats include H.265, H.264, and MJPEG. You can select the preferred encode type from the drop-down menu.

## Resolution

The following table lists the default resolution of the camera.

IP Camera Model		Default Resolution
2MP Vandal Dome Camera Mx-VD2A-2-IR	<b>WDR on/off</b>	H.265/H.264: 1920 × 1080 (30 fps) + MJPEG: 1080p (30 fps)

## Frame Rate

Video frame rate is for setting the frames per second (fps) if necessary.

The default setting of Stream 1 is 30 fps (NTSC) or 25 fps (PAL). The maximum frame rate range of each stream will change according to the selected video resolution.

### NOTE!

- Low frame rate will decrease video smoothness.
- Please make sure the higher compression ratio is supported by the system before setup.

## Profile

You can set H.265/H.264 Profile to **High Profile** or **Main Profile** according to its compression needs. With the same bit rate, the higher the compression ratio, the better the image quality is. The default setting is **Main Profile**.

## Rate Control

The following H.265/H.264 bit rate modes are supported:

- **CBR (Constant Bit Rate)**

The video bitrate of the video stream will be fixed and consistent to maintain the bandwidth.

- **VBR (Variable Bit Rate)**

The video bitrate of the video stream varies according to the activity of the monitoring environment to achieve better image quality.

Click on **Save** to apply and store the settings.

## Bit Rate

The default setting of the H.265/H.264 bit rate for Stream 1/2 is 4096 kbit/s; for Stream 3/4 is 2048 kbit/s. The setting range is from 64 to 20480 kbit/s, and the total bit rate should not exceed 51200 kbit/s.

## GOV Length

You can set the GOV length to determine the frame structure (I-frames and P-frames) in a video stream to save bandwidth. Less bandwidth is needed if the GOV length is set to a high value. However, the shorter the GOV length, the better the video quality is.

The default setting for the available streams is 50. The setting range of the GOV length is from 1 to 4094.

## Q (Quality) Factor (MJPEG Only)

The default setting of MJPEG Q factor is 35; the setting range is from 1 to 70.

## Source

You can set the viewing mode of specific camera models here. The resolution options will vary according to the viewing mode selected from the **Source** drop-down list.

The default setting for Stream 1 is “overview” Mode.

The screenshot shows the 'Video Configuration' interface for 'stream 1'. It contains several settings:

- Encoding: Yes
- Encode Type: H.264
- Resolution: 2048 x 2048
- Rate Control: VBR
- Source: overview (highlighted with a red box)
- Profile: Main profile
- Framerate: 15
- Bitrate: 4096
- GOV Length: 50

Click on **Save** to confirm the setting or click on **Reset** to return to the previous settings.

## Video Rotation

### Rotate Function

You can change video display type if necessary. Selectable video rotate types include Mirror video and 90/180/270 degree clockwise rotate. Refer to the following descriptions for the different video rotate type.

- **Mirror**

Select **yes** from the drop-down menu, and the image will be mirrored horizontally.

- **Rotate Type**

You can choose 0, 90, 180, or 270 degrees from the drop-down menu to rotate the image.

Click on **Save** to apply and store the settings.

## Video Text Overlay

You can select the items to display data including date & time/text string/subtitle/image on the live video pane.

### Overlay Type

You can select at most three items out of four options including date & time/text string/subtitle/image to display on the live video pane.

- **Include Date & Time**

Check the box to enable date & time display on the Live Video Pane and a Video Text Overlay Window will show up. Move the mouse cursor to the center of the window then click and drag the window to preferred display position. You can choose to display date, time, or date & time from the drop-down menu, and decide the string align position (left/right).

- **Include Text String**

Check the box to enable text string display on the Live Video Pane and a Video Text Overlay Window will show up. Move the mouse cursor to the center of the window then click and drag the window to preferred display position. Type the text to display in the entry field and decide the string align position (left/right). The maximum length of the text string is 15 alphanumeric characters.



▪ **Include Subtitle**

Check the box to enable subtitle display on the Live Video Pane and a Video Text Overlay Window will show up. Move the mouse cursor to the center of the window then click and drag the window to preferred display position. Type the text to display in the entry field and decide the string align position (left/right). You can set at most 5 subtitles, and the maximum length of each subtitle is 16 alphanumeric characters.

▪ **Include Image**

Check the box to enable image display on the Live Video Pane and a Video Text Overlay Window will show up. Move the mouse cursor to the center of the window, click and drag the window to preferred display position, and then decide the string align position (left/right).

Click on **Set** to confirm the setting.

## Text Overlay Setting

You can choose the Text Overlay Color (black, white, yellow, red, green, blue, cyan, or magenta) and Text Overlay Size (small, medium, or large) of the display date & time/text string/subtitle.

Click on **Set** to confirm the setting.

## Image Overlay Setting

Users must save the image as a 8-bit BMP file; the length should be the multiple of 32, and the width should be the multiple of 4. The maximum resolution of the image should not exceed 32768 pixels.

Click on **Set** and **Upload** to confirm the setting.

## Video ROI

To edit the video ROI settings, select **Streaming > Video ROI**.

ROI stands for Region of Interest. This function allows users to select specific monitoring region for Stream 1~Stream 4, instead of showing the full image.

**NOTE!** To use ROI function, dual streaming or above must be enabled and the resolution of each streaming must be different.

**NOTE!** Video ROI function is not available when Digital Zoom is open.

## Enable Stream 1 ~ Stream 3 ROI Setting

Only the stream with the second highest resolution among the enabled streams is available for Video ROI Setting.

Check the box on the specific stream to display the ROI Window. Note that Video ROI Setting is NOT available when only 1 stream or all 3 streams are enabled, or when at least two of the streams are set to the same resolution. To adjust the ROI Window, click and drag the edge of the window outward/inward. To shift the window to the intended location, click the center of the ROI Window and drag the mouse cursor.

Click **Save** to apply the setting.

## Enable Stream 1 ~ Stream 4 ROI Setting

Check the boxes and Stream 1~ Stream 4 ROI Window will be displayed. Note that video ROI is NOT available for the streaming set as the highest resolution among the enabled streaming. To adjust the ROI Window, click and drag the edge of the window outward/inward. To shift the window to the intended location, click the center of the ROI Window and drag the mouse cursor.

Click **Save** to apply the setting.

## Video ROI Encoding

To edit the video ROI encoding settings, select **Streaming > Video ROI Encoding**.

Video ROI Encoding is to set the compression of the selected zone within ROI for better performances; at most three zones can be set in the interested region. However, this function does NOT support MJPEG video format.

The following shows how to setup Video ROI Encoding. To implement this function, Video ROI must be setup beforehand.

- Select a video stream from **Video Stream**.
- Select **Enable** from **ROI Encoding** to implement ROI Encoding.
- Click on **Add**, click and drag the center of the window to move it to the interested location; click and drag the edge of the window outward/inward to resize the window.

**NOTE!** The total size of the three windows CANNOT be larger than the half size of the ROI. When exceeds, a warning window will pop up.

- Choose the quality of the setting zone from **Quality**.  
The higher the value, the better the image quality (higher bit rate) of the setting zone will be. On the contrary, the lower the value, the lower the image quality (lower bit rate) of the selected area will be.
- Click on **Save** to apply and store the settings.

## Video OCX Protocol

To edit the video OCX protocol settings, select **Streaming > Video OCX Protocol**.

In the **Video OCX protocol** setting page, the administrator can select RTP over UDP, RTP over RTSP (TCP), RTSP over HTTP or MJPEG over HTTP, for streaming media over the network. In the case of multicast networking, you can select the Multicast mode. Click on **Save** to confirm the setting.

Video OCX protocol setting options include:

- **RTP over UDP/RTP over RTSP(TCP) / RTSP over HTTP/MJPEG over HTTP**
- **Multicast Mode**  
Enter all required data, including **Multicast Stream 1~4 Video Address**, **Multicast Port** and **Multicast TTL** into each blank.

Click on **Save** to apply and store the settings.

## Video Mask

To edit the video mask settings, select **Streaming > Video Mask**.

### Active Mask Function

- **Add a Mask**  
Check a Video Mask checkbox, and a red frame will come out in the Live Video pane. Use the mouse to drag and drop to adjust the mask’s size and place it on the target zone. At most 5 video masks can be set.

**NOTE!** It is suggested to set the Video Mask slightly bigger than the object.

- **Cancel a Mask**  
Un-check the Video Mask checkbox meant to be deleted; the mask will disappear from the Live Video pane instantly.

## Mask Setting

- **Mask color**

The selections of Mask color include black, white, yellow, red, green, blue, cyan, and magenta. Click on **Save** to apply and store the settings.

# The “Camera” Tab

The screenshot shows the MOBOTIXMOVE web interface. At the top, there is a navigation bar with the following items: Home, System, Streaming, Camera (highlighted), and Logout. On the right side of the navigation bar, there is a language selector set to "English". Below the navigation bar, a sidebar on the left contains a list of camera settings: Exposure, White Balance, Picture Adjustment, Color Style, IR Function, Noise Reduction, WDR Function, Digital Zoom, Backlight, Profile, and TV System. A "Linear (max 25)" slider is visible below the settings list. The main content area displays a live video stream of a train station platform with several high-speed trains. The stream is labeled "Stream 1" and has a timestamp of "2021/09/03 11:51". At the bottom right of the video stream, there is a control panel with icons for: Full Screen, Microphone, Mute, Camera, Stop, and Record.

## Exposure

To edit the exposure settings, select **Camera > Exposure**.

Exposure is the amount of light received by the image sensor. It is determined by the width of lens diaphragm opening, the shutter speed and other exposure parameters. With these items, you can define how the Auto Exposure function works. You can select one of the exposure modes according to the operating environment. Each exposure mode is specified as follows.

**NOTE!** The available settings and the shutter speed range will vary depending on the lens/CMOS sensor combination.

## Auto Mode

### ■ Window Setting

With this function, you can determine which area of the camera scene is used to calculate the exposure. Follow the steps below to set the Auto Exposure (AE) window.

- Point the camera to the monitoring area.
- Select **On** to enable the function.
- Click and drag the center of the AE window to move it to the interested location; click and drag the edge of the window outward / inward to resize the window.
- Click on  and the camera will automatically adjust the exposure parameters according to the light condition of the user defined area.

**NOTE!** AE Window Setting function is **NOT** available when TV system is set as **WDR 2 Shutter**.

### ■ Max Gain

Maximum Gain can be set to reduce image noises. The Max Gain ranges from 3 dB to 48 dB, or select **Off** to disable the function. The default setting is 48 dB.

### ■ Auto Iris



In this mode, the camera will automatically adjust the iris to suit the environment illumination. The minimum shutter speed can be set from 1/30 to 1 sec. (NTSC) or 1/25 to 1/3 sec. (PAL). AGC (Auto Gain Control) will function automatically according to the light conditions of the subject.

### ■ P-Iris Priority Mode

P-iris priority mode is only available for Zoom Lens and Motorized Lens models. In addition, applied with different lens, the related setting options also vary. Refer to the following for further details.



#### ■ Zoom Lens

Select **Auto Detect** and the camera will automatically detect the best iris size for the environment. Alternatively, you can manually adjust the iris size by selecting **Manual**.

Click  and  to adjust the iris size. The minimum shutter speed can be set from 1/30 to 1 sec. (NTSC) or 1/25 to 1/1.5 sec. (PAL).

#### ■ Motorized Lens

Click on , and the camera will automatically detect the best iris size for the environment. If necessary, you can select and manually to adjust the iris size. Alternatively,

click on  to reset the iris size, and the iris size will be set to the largest. Then, you can manually adjust the iris size by selecting  and . The minimum shutter speed can be set from 1/500 to 1/2 sec. (NTSC) or 1/425 to 1/3 sec. (PAL).

### ■ Iris Priority Mode

In this mode, it is the iris that has premier priority in control of the exposure. The range of the iris size is from 0 to 9, or select **Full open** to fully open the iris. The minimum shutter speed can be set from 1/30 to 1 sec. (NTSC) or 1/25 to 1/1.5 sec. (PAL).

### ■ Auto Shutter Mode

In this mode, the camera will automatically adjust the shutter speed and the iris size according to the light intensity. It is also effective if a fixed iris lens is being used. The minimum shutter speed range is configurable from 1/500 to 1/2 sec. (NTSC) or 1/425 to 1/3 sec. (PAL).

### ■ Shutter Priority Mode







In this mode, it is the shutter speed that takes the main control of the exposure. The range is configurable from 1/500 to 1/30 sec. (NTSC) or 1/425 or 1/25 sec. (PAL).

## Manual Mode

With this mode, you can select the suitable shutter speed, iris size and gain value according to the environmental illumination. The shutter speed ranges from 1/10000 to 1 sec. (NTSC) or from 1/10000 to 1/1.5 sec. (PAL).

The range of the iris size is from 0 to 9, or select **Full open** to fully open the iris. The gain value range is from 3 dB to 48 dB, or select **Off** to disable the function.

**NOTE!** The **Iris Size** setting is only available for models with Zoom Lens.

**NOTE!** For Motorized Lens models, the iris size setting differs. To set the iris size, click on , and the camera will auto detect the best iris size for the environment. If necessary, users still can manually adjust the iris size by selecting  and . Alternatively, click on  to reset the iris size. The iris size will be set to the largest. Then, you can manually adjust the iris size by selecting  and .

## White Balance

To edit the white balance settings, select **Camera > White Balance**.

A camera needs to find reference color temperature, which is a way of measuring the quality of a light source, for calculating all the other colors. The unit for measuring this ratio is in degree Kelvin (K). You can select one of the White Balance Control modes according to the operating environment. The following table shows the color temperature of some light sources for reference.

Light Sources	Color Temperature in K
Cloudy Sky	6,000 to 8,000
Noon Sun and Clear Sky	6,500
Household Lighting	2,500 to 3,000
75-watt Bulb	2,820
Candle Flame	1,200 to 1,500

## Auto Mode

The Auto White Balance mode is suitable for environments with light source having color temperature in the range roughly from 2700K to 7800K.

## ATW Mode (Auto Tracking White Balance)

With Auto Tracking White Balance function, the white balance in a scene will be automatically adjusted while temperature color is changing. The AWB.wide mode is suitable for environments with light source having color temperature in the range roughly from 2500K to 10000K.

## AWB.normal

The AWB (Auto White Balance).normal mode is suitable for environments with light source having color temperature in the range roughly from 2700K to 7800K.



## AWB.wide

With AWB (Auto White Balance).wide function, the white balance in a scene will be automatically adjusted while temperature color is changing. The AWB.wide mode is suitable for environments with light source having color temperature in the range roughly from 2500K to 10000K.

## AWB.all

The AWB (Auto White Balance).all mode is suitable for environments with light source having color temperature under 2500K or over 10000K.

## Smart Mode

The Smart mode is suitable for environments with one single background color which is strongly saturated, for instance, in a forest.

## One Push

With One Push function, white balance is adjusted and fixed according to the scene the camera currently sees. This function is best for situations with minimal scene changes and continuous lighting. The function is suitable for light sources with any kind of color temperature. Follow the steps below to set the white balance.

- Point the camera to the monitoring area.
- Select **One Push** in the White Balance setting menu
- Click the  button to adjust the color tone of the live images.

**NOTE!** In this mode, the value of white balance will not change as the scene or the light source varies. Therefore, users might have to re-adjust the white balance by clicking the  button again when needed.

## Smart Touch Mode

With Smart Touch function, you can select an area in the camera scene as the reference point for white balance. Please ensure that the background color of the selected area is white. Smart Touch function is suitable for environments with unchanged brightness level.

## Manual Mode

In this mode, you can manually adjust the White Balance value. Input a number between 0 to 249 for “Rgain/Bgain” to adjust the red/blue illuminant on the Live Video Pane. The following describes several situations that might occur during the White Balance manual adjustment.

- The video image turns reddish (as the left picture below).

The higher the Rgain value, the redder the image will be. To solve the problem, reduce the Rgain value, and the video image will turn less reddish.



Reddish Image



Corrected White Balance

- The video image turns greenish (as the left picture below).

The lower the Rgain value, the greener the image will be. To solve the problem, increase the Rgain value, and the video image will turn less greenish.



Greenish Image



Corrected White Balance

- The video image turns bluish (as the left picture below).

The higher the Bgain value, the bluer the image will be. To solve the problem, reduce the Bgain value, and the video image will turn less bluish.



Bluish Image



Corrected White Balance

## Menu Reference

### The “Camera” Tab

- The video image turns yellowish (as the left picture below).  
The lower the Bgain value, the yellower the image will be. To solve the problem, Increase the Bgain value, and the video image will turn less yellowish.



The following image displays the general color shifts of the scene when different Rgain/Bgain combinations are applied.



## Picture Adjustment

To edit the picture adjustment settings, select **Camera > Picture Adjustment**.

- **Brightness**  
The brightness level of the images is adjustable from -12 to +13. The default value is 0.

- **Sharpness**

The sharpness level of the images is adjustable from +0 to +15. The edge of the objects is enhanced as the sharpness level increases. The default value is +4.

- **Contrast**

The contrast level of the images is adjustable from -6 to +19. The default value is 0.

- **Saturation**

The saturation level of the images is adjustable from -6 to +19. The default value is 0.

- **Hue**

The hue level of the images is adjustable from -12 to +13. The default value is 0.

## Color Style

To edit the color style settings, select **Camera >Color Style**.

Color style can automatically adjust the brightness, allowing users to select the best color style mode based on the operating environment.

- **Normal**

The default setting is normal mode.

- **Dark Detail Brighter**

This mode increases brightness on dark areas of the image.

- **Highlight Detail Brighter**

This mode increases brightness on general-illuminated areas of the image.

## IR Function

To edit the IR function settings, select **Camera > IR Function**.

### Day/Night Function

This item is for users to define the action of the IR cut filter and IR LED lights. Refer to the descriptions of each option below to select a suitable mode.

- **Auto**

With this mode, the camera will decide when to remove the IR cut filter. Please refer to [Day/Night Threshold, p. 86](#) for further details.

- **Night**

Use this mode when the environment light level is low. The IR cut filter will be removed to allow the camera to deliver clear images in black and white.

- **Day**

Select this mode to turn on the IR cut filter. The IR cut filter can filter out the IR light and allows the camera to deliver high quality images in color.

- **Light Sensor(Default)**

In this mode, for cameras with built-in IR LED modules, the light sensor will decide the occasion to turn the IR LED lights on/off. For cameras with non-IR modules, the light sensor will decide the occasion to take the IR cut filter on/off.

- **Light On (Built-in IR LED Modules Only)**

In this mode, IR LED lights will always be on.

- **Light Off (Built-in IR LED Modules Only)**

In this mode, IR LED lights will always be off.

- **Smart**

With Smart mode, the camera will decide the occasion to remove the IR cut filter. The Smart mode mechanism can judge whether the main light source is from IR illumination. If so, the IR cut filter will be kept removed (i.e. monochrome/night mode).

**NOTE!** It is recommended to select “Smart Mode” when the camera sets high zoom ratio for close-up view.

## Day/Night Threshold

This item is for users to set when the camera should switch from day mode to night mode or vice versa. The camera will sense the surrounding brightness, and the threshold value stands for the level of the light. Once the camera detects the light level reaches the set threshold, the camera will automatically switch to Day/Night Mode. The range of the level is from 0 to 10, (darker = 0; brighter = 10).

- **Night Mode to Day Mode** 

The lower the value, the earlier the camera switches to Day mode. The default value is 7.

- **Day Mode to Night Mode** 

The higher the value, the earlier the camera switches to Night mode. The default value is 3.

**NOTE!** Equipped with different CMOS sensors, the time the camera switches to Day/Night mode may also vary from models to models even if the threshold is set to the same value.

## IR Light Compensation

With the IR Light Compensation function, the camera can prevent the center object close to the camera from being too bright when IR LED lights are turned on.

**NOTE!** IR Light Compensation function is **NOT** available when **Auto Exposure Window Setting** function is enabled.

## IR Heating

IR heating function is provided for cameras installed under icy and humid environment. Activate the function to avoid ice accumulating on the surface.

## Noise Reduction

To edit the noise reduction settings, select **Camera > Noise Reduction**.

The camera provides multiple **Noise Reduction** options for delivering optimized image quality especially in extra low-light conditions.

### 3DNR

3DNR (3D Noise Reduction) function delivers optimized image quality especially in extra low-light conditions.

Different levels of 3DNR are provided, including 3DNR Low, 3DNR Mid and 3DNR High. Higher level of 3DNR generates relatively enhanced noise reduction.

### 2DNR

2DNR (2D Noise Reduction) function delivers clear images without motion blurs in extra low-light conditions.

Select **on** to turn on 2DNR function; otherwise, select **off** to turn off 2DNR function.

### ColorNR

In a dark or insufficient light environment and the camera is under color mode, ColorNR (Color Noise Reduction) can eliminate color noise.

Three levels of ColorNR, including Color Low, Color Mid and Color High, are provided. The higher level of ColorNR generates relatively enhanced noise reduction.

## WDR Function

To edit the WDR settings, select **Camera > WDR Function**.

The Wide Dynamic Range (WDR) function is for solving high contrast or changing light issues to enhance video display quality. Different level options for WDR include Low, Mid and Hi. Higher level of WDR represents wider dynamic range, so that the camera can catch a greater scale of brightness.

## Digital Zoom

To edit the digital zoom settings, select **Camera > Digital Zoom**.

Select **On** to enable digital zoom, select **Off** to disable the function.

## Backlight

To edit the backlight settings, select **Camera > Backlight**. This function will be available when the video format in [TV System, p. 89](#) has been set to “60fps” or “50fps”.

**NOTE!** Backlight function is **not** available when [TV System, p. 89](#) has been set to *WDR 2 Shutter*.

Backlight compensation prevents the center object from being too dark in surroundings where excessive light is behind the center object. Select **on** to turn on the function; otherwise, select **off** to turn off the function.

## Defog

Click on **Camera > Defog** and select *On* to improve the camera images in foggy conditions. In this mode, the camera applies contrast enhancement to improve the colors in the images.



## Profile

To edit the camera profile settings, select **Camera > Profile**.

Camera Profile allows users to setup the desired image parameters for specific environments with different time schedules. You can setup at most 10 sets of camera parameter configuration under the Camera tab. To enable this function, users must setup the schedules in advance. Refer to section [Schedule](#) for further details of schedule setup. Then, follow the steps below to setup a camera profile.



## Camera Profile Setup

1. In the “Camera” tab, setup the camera parameters, such as White Balance, Picture Adjustment, etc., excluding TV System.
2. Click on Profile and its setting menu will be displayed. Select a number from the Num drop-down menu.
3. Input a name for the profile in the Name field.
4. Click on  below the Name field. The camera configuration is saved and applied to the profile. Now a camera profile is created and saved.
5. Select a profile from the Num drop-down menu.
6. Tick the By schedule box. Check the desired schedule(s) from the Schedule drop-down menu. Multiple schedules can be applied to one profile.
7. Click on  below **By schedule**.
8. Follow the steps above to set the rest of the profiles.

Now, the camera will automatically switch profiles according to the schedule. Alternatively, manually select a number from the Num drop-down menu. Then, click on , the camera will load and apply the setting of the profile.

**NOTE!** If users wish to set the camera parameters to factory default setting, select **Normal** from the Num drop-down menu. The camera will start loading the default values.

**NOTE!** Users **MUST** set the camera parameter of the last profile as the default setting. Thus, if there are gaps among schedules, the camera will apply the setting of the last profile.

## TV System

To edit the TV system settings, select **Camera > TV System**.

Select the video format that matches the present TV system from the drop-down menu. The following table shows the available video formats for different types of models. The supported video formats for each model are marked by “✓”.

Video Format	2MP Vandal Dome Camera
NTSC 30 fps	✓
WDR 2 Shutter	✓

## Menu Reference

### The “Camera” Tab

---

Video Format		2MP Vandal Dome Camera
PAL	25 fps	✓
	WDR 2 Shutter	✓

---

## The “Logout” Tab

Click on the tab **Logout** on the top of the page, and the login window will pop up. This enables logging in with a different username.

## Appendix A: Installing UPnP Components

Please follow the instructions below to install UPnP components on Windows computers.

1. In Windows, go to **Start**, click on **Control Panel**, and then double-click on **Add or Remove Programs**.
2. Click on **Add/Remove Windows Components** in the **Add or Remove Programs** page.
3. Select **Networking Services** from the Components list in Components Wizard window of the Windows, and then click **Details**.
4. Select **UPnP User Interface** in the Networking Services' subcomponents list and then click on **OK**.
5. Click on **Next** in the Windows Components Wizard window.
6. Click on **Finish** to complete installation.

## Appendix B: Converting IP Addresses from Decimal to Binary

Follow the example below to convert the IP addresses to binary numbers. Use the calculator on the computer for conversion: **Start > All Programs > Accessories > Calculator**.

- Windows 7/8: Click **View** on the calculator and click **Programmer**.
- Windows 10/11: Click on the menu button  and select **Programmer**.

The example below shows how to convert 192.168.2.81 to binary numbers.

1. On the left of the calculator, select **Dec**. Then enter the first decimal number of the IP address, “192”. Select **Bin** and the number will be converted to binary number. Repeat the same procedure with the rest of decimal numbers. Remember to select **Dec** before entering the next decimal number. Otherwise a decimal number cannot be entered. The table below shows the binary representation of each decimal number.

**Decimal Numbers    Binary Numbers**

192	11000000
168	10101000
2	10
81	1010001

2. Each binary number should have eight digits. If a binary number does not have eight digits, please add leading zeros until it does. The binary number of each decimal number should be as follows.

**Decimal Numbers    Binary Numbers**

192	11000000
168	10101000
2	<b>00000010</b>
81	<b>01010001</b>

Therefore, the binary representation of IP address 192.168.2.81 is

**11000000.10101000.00000010.01010001.**

## Appendix C: List of Open/Closed IP Ports

The following tables list the ports for the TCP and UDP IP protocols on the MOBOTIX MOVE cameras.

### TCP Protocol

Port number	Service	Default
Port number	Service	Default
80	HTTP	open
443	HTTPS	open
554	RTSP	open
5555	UPnP	open

### UDP Protocol

Port number	Service	Default
68	DHCP	open
161	SNMP	closed
1900	UPnP	open
3702	ONVIF Probe	open
5353	Bonjour	open
6666	Device Search (Dynacolor search tool)	open
15070	audio talk (RTP from PC to IPCam)	closed
15071	audio talk (RTCP)	closed
18890	stream1 video multicast RTP port	open
18891	stream1 video multicast RTCP port	open
18900	stream2 video multicast RTP port	open
18901	stream2 video multicast RTCP port	open
18910	stream3 video multicast RTP port	open

<b>Port number</b>	<b>Service</b>	<b>Default</b>
18911	stream3 video multicast RTCP port	open
18920	stream4 video multicast RTP port	open
18921	stream4 video multicast RTCP port	open
18930	audio multicast RTP port	open
18931	audio multicast RTCP port	open
18940	meta-data multicast RTP port	open
18941	meta-data multicast RTCP port	open
19800	MxMessage system	open

---





## Technical Support Information

This section contains the following information:

<b>Technical Specifications</b> .....	<b>98</b>
---------------------------------------	-----------

# Technical Specifications

## Product Information

Product Name	2MP Vandal Dome Camera
Order Code	Mx-VD2A-2-IR

## Image Quality

Image Sensor	5MP, 1/2.7" Progressive scan
Effective (Used) Pixels	H x V = 1920x1080 (2MP)
Pixel Size	2.0 $\mu\text{m}$
Frame Rate (maximum)	<p><b>WDR on:</b></p> <p>H.265/H.264: 1920x1080@30fps + 720x480@30fps</p> <p>MJPEG: 1080p@30fps</p> <p><b>WDR off:</b></p> <p>H.265/H.264: 1920x1080@30fps + 720x480@30fps</p> <p>MJPEG: 1080p@30fps</p>

## Lens

Minimum Illumination	<p>Color: 0.08 lux</p> <p>B/W: 0.008 lux</p>
Lens Characteristics	<p>Manual Vari-Focal Lens</p> <p>Focal Length: 2.8 to 12 mm</p> <p>Aperture: F1.4 to F2.8</p> <p>Horizontal Field of View: 96.76° (Wide), 34.13° (Tele)</p> <p>Vertical Field of View: 52.21° (Wide), 19.24° (Tele)</p>
Lens Mechanics	3-Axis adjustment

## Camera

Day/Night	Automatic mechanically switchable IR-cut filter
Shutter Time	<p><b>Manual mode:</b></p> <p>WDR: 1/17550 s</p> <p>Linear: 30 fps, 1/37440 s</p> <p><b>Automatic Mode:</b></p> <p>1 to 1/10000 s</p>
WDR	Up to 130 dB Multi Exposure WDR & HDR Engine support
Zoom	Optical: 4.29x, Digital: 10x
Image settings	Color, Brightness, Sharpness, Contrast, White Balance, Exposure Control, 2DNR, 3DNR, NR by Motion, Masking, Text Overlay
Corridor Mode	90°, 180°, 270° Rotation

## Video Codec

Compression/Encoding	H.265/H.264/MJPEG
Streaming	Up to 4 individually configurable streams in H.264/H.265/MJPEG; configurable resolution, frame rate, bandwidth LBR/VBR/CBR in H.265/H.264.

## Cyber Security Features

Password Protection	Yes (including “forced” password change during initial setup)
IP address filtering	Yes (to restrict unauthorized access based on IP addresses)
IEEE 802.1X network access control	Yes (for advanced network security and authentication)
Digest authentication	Yes (for secure user authentication)
Secure Boot	Yes (support of fixed IP setting and automatic DHCP IP configuration according to individual MAC address)
AES encryption for password protection	Yes (to ensure strong encryption for password storage)

## Technical Support Information

### Technical Specifications

---

HTTPS/SSL (using TLS)	Yes (TLS 1.2 default, TLS 1.0/1.1 optional selectable)
User and Group Management	Yes (for fine-grained access control)
VPN	Yes (to establish secure network connections)
Digitally signed firmware	Yes (to prevent firmware file tampering)
RSA encryption	Yes (to support stronger ciphers; supported: RSA (2048 bits), AES-128, AES-256, SHA-256, SHA-384)

---

## Network

Interface	10/100 Mbps Ethernet
Supported Protocols	ARP, PPPoE, IPv4/v6, ICMP, IGMP, QoS, TCP, UDP, DHCP, UPnP, SNMP, SMTP, RTP, RTSP, HTTP, HTTPS, FTP, NTP, DDNS, SMBv2
ONVIF conformance	Supports profiles S/G/T/M
Supported Browsers	All current browsers (e.g. Microsoft Edge, Firefox, Google Chrome, Opera, etc.) are supported.

---

## System Integration

Base Video Analytics	<ul style="list-style-type: none"><li>■ Motion Detection</li><li>■ Tampering</li></ul>
Event Triggers	<ul style="list-style-type: none"><li>■ Analytics</li><li>■ Network failure detection</li><li>■ Periodical event</li><li>■ Manual trigger</li></ul>
Event Actions	<ul style="list-style-type: none"><li>■ Video recording to edge storage</li><li>■ File upload: FTP, network share and email</li><li>■ Notification: HTTP, FTP, email</li></ul>

---

## General

Casing	Metal Housing
Power Requirements	PoE IEEE802.3af, class 0, max. 7.5 W

---

PoE Modes Supported	Mode A or Mode B
Connectors	RJ45
IR Illumination	850 nm; up to 40 m distance depending on scenery reflection
Video Storage	Micro SD/SDHC/SDXC card support up to 1 TB, Support for recording to NAS, MOBOTIX HUB, MOBOTIX MOVE NVR
Environmental Protection Class	IP66/IK10
Operating Temperature	-55 to 60 °C/-67 to 140 °F
Cold Start Temperature	-20 °C/-4 °F
Relative Humidity	10 to 90 % non-condensing 10 to 95 % non-condensing
Storage Conditions	-20 to 70 °C/-4 to 158 °F -40 to 60 °C/-4 to 158 °F
Approvals	EMC: CE/FCC, Safety: LVD, Environmental: IP66, IK10
MTBF	95,000 hours
Warranty	5 years
Dimensions	ø 133.8 x 117.4 mm
Weight	760 g

**NOTE!** Observe the [MOBOTIX MOVE Installation Hints](#) document to ensure optimum performance of the camera features.

# MOBOTIX

BeyondHumanVision

[EN\\_01/24](#)

MOBOTIX AG • Kaiserstrasse • D-67722 Langmeil • Tel.: +49 6302 9816-103 • [sales@mobotix.com](mailto:sales@mobotix.com) • [www.mobotix.com](http://www.mobotix.com)

MOBOTIX is a trademark of MOBOTIX AG registered in the European Union, the U.S.A., and in other countries. Subject to change without notice. MOBOTIX do not assume any liability for technical or editorial errors or omissions contained herein. All rights reserved. © MOBOTIX AG 2020